

Operating Instructions Bedienungsanleitung Manuel d'instructions Manuale di istruzioni Manual de Instrucciones

In-Dash 7" Wide Color LCD Monitor with RDS Receiver and Changer Control
7-Zoll Breitbild-LCD-Farbmonitor mit RDS-Receiver und Wechslersteuerung
für den Einbau in das Armaturenbrett

Moniteur à cristaux liquides couleur grand écran de 7,0 pouces avec récepteur RDS et
commande de changeur intégré en tableau de bord
Monitor LCD a schermo ampio di 7" per cruscotto con
ricevitore RDS e controllo cambiadischi (AUTORADIO)

Monitor de pantalla ancha de LCD en color de 7 pulgadas con receptor RDS y control de
cambiador de discos para el tablero de instrumentos

CQ-VA707N

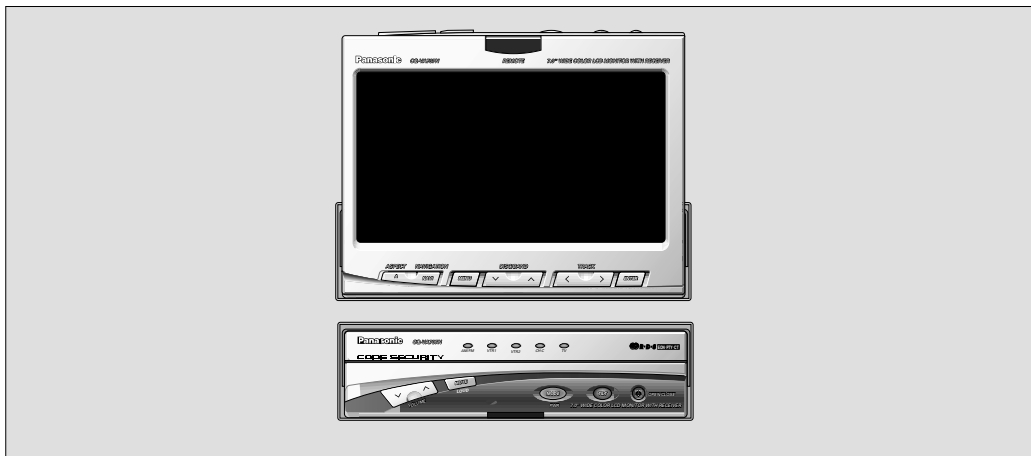

Panasonic

Please read these instructions carefully before using this product and save this manual for future use.

Bitte lesen Sie diese Bedienungsanleitung vor der Verwendung dieses Produktes aufmerksam
durch und bewahren Sie sie danach für spätere Nachschlagezwecke sorgfältig auf.

Prrière de lire ces instructions attentivement avant d'utiliser le produit
et garder ce manuel pour l'utilisation ultérieure.

Si prega di leggere attentamente queste istruzioni prima di usare questo prodotto
e di conservare questo manuale per usi futuri.

Lea con atención estas instrucciones antes de utilizar el producto
y guarde este manual para poderlo consultar en el futuro.

Contents

	Page		Page
Features	4	Radio Basics	34
Precautions	5	Radio Data System (RDS)	36
ID Code	5	CD Changer Basics	44
Remote Control Preparation	6	Auxiliary	48
Names of Controls	7	Installation	50
Before Use	11	Electrical Connections	55
User Settings	16	Troubleshooting	62
Sound Settings	28	Maintenance	66
Screen Adjustment	30	Specifications	67
Operation: General	32		

Panasonic welcomes you to their constantly growing family of electronic products owners. We endeavor to give you the advantages of precise electronic and mechanical engineering, manufactured with carefully selected components, and assembled by people who are proud of the reputation their work has built for our company. We know this product will bring you many hours of enjoyment, and after you discover the quality, value and reliability we have built into it, you too will be proud to be a member of our family.

□ Features

- **7-inch wide LCD color display**

Delivers images of high quality and superb color reproduction.

- **Fully powered display positioning mechanism (except for lateral angle)**

Positioning of the display unit is fully power driven. This includes extending the unit, raising it to upright position, adjusting its vertical (tilt) angle and moving it to the front and rear.

The lateral angle to the right and left can be adjusted manually.

- **Radio tuner [for FM/AM(LW/MW)] and RDS function are integrated.**

- **CD Changer control function**

Allows system expansion by adding an optional CD Changer (CX-DP88N, CX-DP9061EN, etc.).

When the unit is connected with a CD text recognizable CD changer (CX-DP9061EN, for example), CD text can appear on the display.

- **ID code setup**

4-digit ID code for increased security (The figures 1 to 6 can be used.)

- **The speaker for the car navigation system is integrated in the display unit.**

We designed a small speaker which is built-in the display unit.

This speaker is used only for Panasonic car navigation system (CN-DV2000EN, for example).

- **Rear-view camera automatic selection (Rear-view camera is optional.)**

When you put a car in reverse, a picture taken by the rear-view camera is displayed on a screen automatically.

* An optional TV tuner (CY-TN1500PEN) is required to receive TV broadcast.

WARNING:

TO AVOID THE RISK OF SERIOUS INJURY OR POSSIBLE VIOLATION OF LAWS, DO NOT USE WHERE VISIBLE TO DRIVER FOR ANY PURPOSE OTHER THAN NAVIGATION OR USE WITH REAR VIEW CAMERA.

When Driving

- The driver must not operate the color LCD monitor. Operating the color LCD monitor may lead to distraction and cause an accident. Stop your vehicle in a safe location when operating the unit.
- The driver must not watch videos while driving. It may lead to distraction and cause an accident.
- Keep the unit at an appropriate sound level. Driving with the sound at a level that prevents you from hearing sounds outside and around the vehicle may cause an accident.

Precautions

Car Washing

To avoid electrical shorts which may cause a fire or other damage, do not expose this product to water or excessive moisture.

Car Ventilation

If your car is parked for several hours in direct sunlight, the temperature inside the car may become very high. It is advisable to drive the car and give the interior a chance to cool down before switching the unit on.

Power Supply

This product is designed to be used in a car having a 12-volt negative ground battery system.

Service

This product is made of precision parts. Do not attempt to disassemble or adjust any parts. For repair, please consult your nearest authorized Panasonic Service Center.

About Preset Memory

The preset memory is cleared to return to the original factory setting when the power connector or battery is disconnected.

For Installation

- Install the monitor in a position that does not obstruct the driver's vision.
- Do not install the control unit in the following types of location:

A location which is exposed to water, a location where it could be stepped on, or a location which is exposed to hot air such as near a heater duct.

- Do not install the unit in an area where it would obstruct the operation of an air bag.
- Ask a trained technician to install the unit. Installation and wiring require training and experience.

To be safe, ask the sales outlet where you purchased the unit to perform the installation.

When Operating

- Do not let the unit fall or be strongly impacted since this may cause a malfunction or fire.

When Parked

- Do not watch the monitor with the engine off. It will consume battery power and may prevent the engine from starting.

ID Code

Prior to operating this unit, it is advisable to assign your 4-digit ID code for security. (The figures **1 to 6 can be used**. The figures 7 to 9 and 0 are not available. Make sure to use **four digits** for ID code. ID code can not be set with two or three digits.)

Once the ID code has been set, the unit cannot be operated if the main power supply is disconnected then re-connected. It is electronically locked up so that the thief could not use the stolen unit unless that person knows the code you have set.

The ID code operation must be performed only by the person whom the unit belongs to.

Generally, it is not necessary to enter the ID code each time when using the unit if it has never been disconnected from the main power supply (car battery). For the ID code setting procedures, see pages 19 to 21.

Caution:

Record your registered ID code and keep it in a secure location.
If you forget it, you will be unable to use the unit.

Remote Control Preparation

Battery Insertion

- 1. Open the battery holder cover.**
Lightly depress the cover and slide it out.
- 2. Insert the battery.**
Insert batteries in the correct direction, making sure that their positive (+) and negative (-) ends match the same symbols in the battery holder.
- 3. Replace the cover.**
The cover is fixed in place with a click.

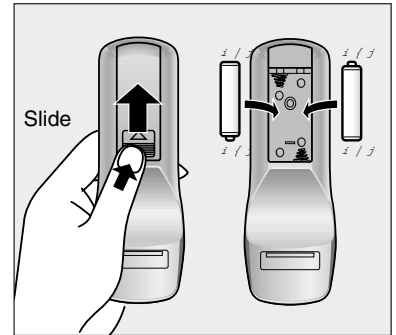

Battery Notes

- **Battery type:** Batteries to be used: Two manganese UM4 dry cells (R03) (do not use alkaline dry cells.)
- **Battery life:** About 5 months under normal conditions of use. (Manganese dry cells at normal temperature)

Caution:

Improper use of batteries may cause overheating, explosion or ignition, resulting in injury or fire. Battery leakage may cause damage to the unit.

- Do not disassemble or short the batteries. Do not throw the batteries into a fire.
- To avoid the risk of an accident, keep the batteries away from children.
- To store batteries, insulate them with tape or the like. Contact with metallic objects or other batteries can cause ignition or rupture.
- If the batteries are used in the wrong way, there is the danger of liquid leakage, rupture, injuries, and failure. (Insert batteries correctly with respect to their positive (+) and negative (-) ends.)

Caution:

When decayed, follow the rules and regulations of your country.

Names of Controls

Warning:

For safe driving, the operation is possible only when stopped with the parking brake engaged. "WARNING" will be displayed, if you try to switch to VTR1 or VTR2 mode by pressing the [MODE] button while driving.

Remote Control Unit

To use the remote control, direct it at REMOTE (remote control light sensor) on the display unit. (→ the next page)

There are differences in the control buttons between the remote control and the display unit. If the remote control does not have the button you wish to use, operate it on the display unit.

- Button not on the remote control.....[TILT] button

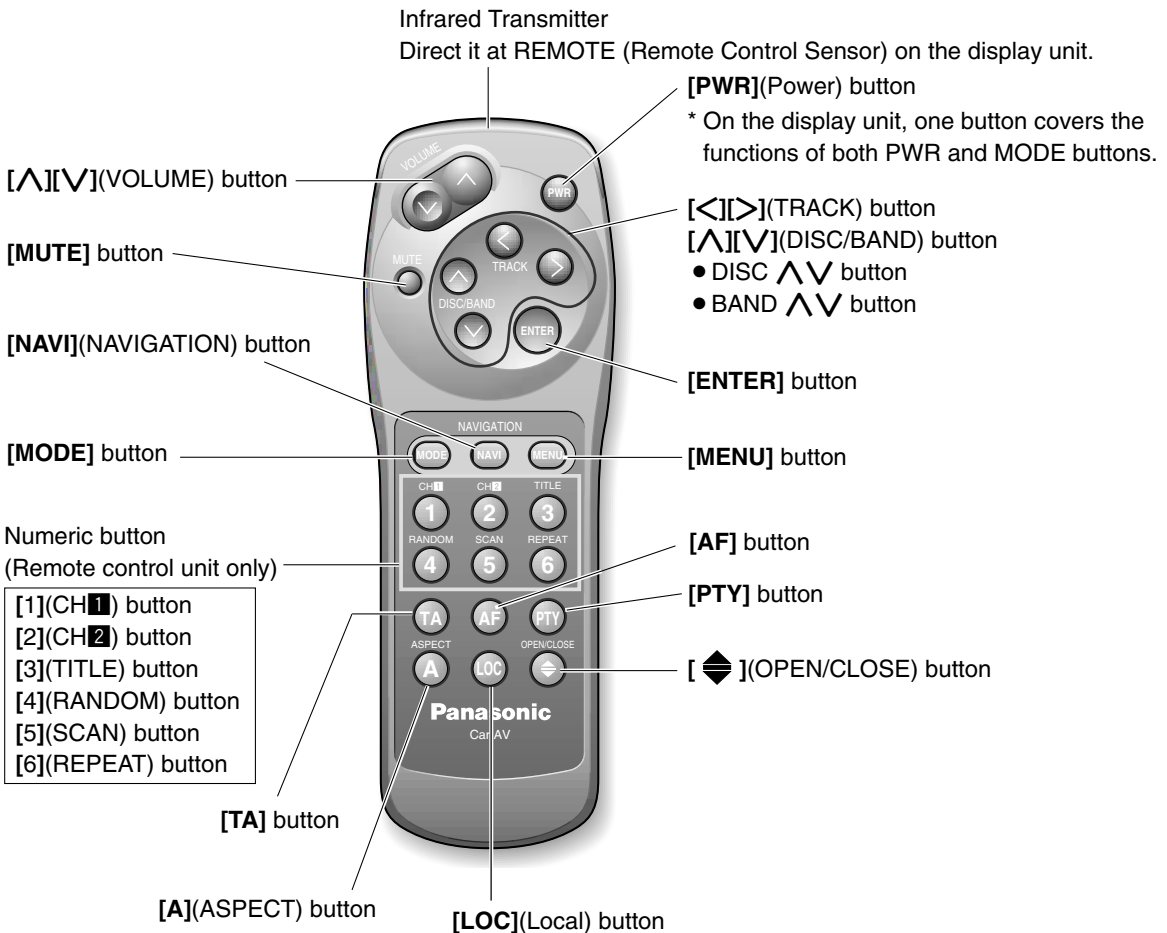

Note:

If the display unit is in the retracted position, the [MENU], [NAVI](NAVIGATION), and [A](ASPECT) buttons cannot be used.

Names of Controls (Continued)

Operate the controls on the display unit in the same way as you operate the remote control buttons.

There are differences in the control buttons between the display unit and the remote control unit. If the display unit does not have the button you wish to use, operate it on the remote control unit.

- Buttons not on the display unit:

[1](CH \blacksquare) button	[4](RANDOM) button	[TA] button
[2](CH \blacksquare) button	[5](SCAN) button	[AF] button
[3](TITLE) button	[6](REPEAT) button	[PTY] button
		[LOC] button

Display Unit

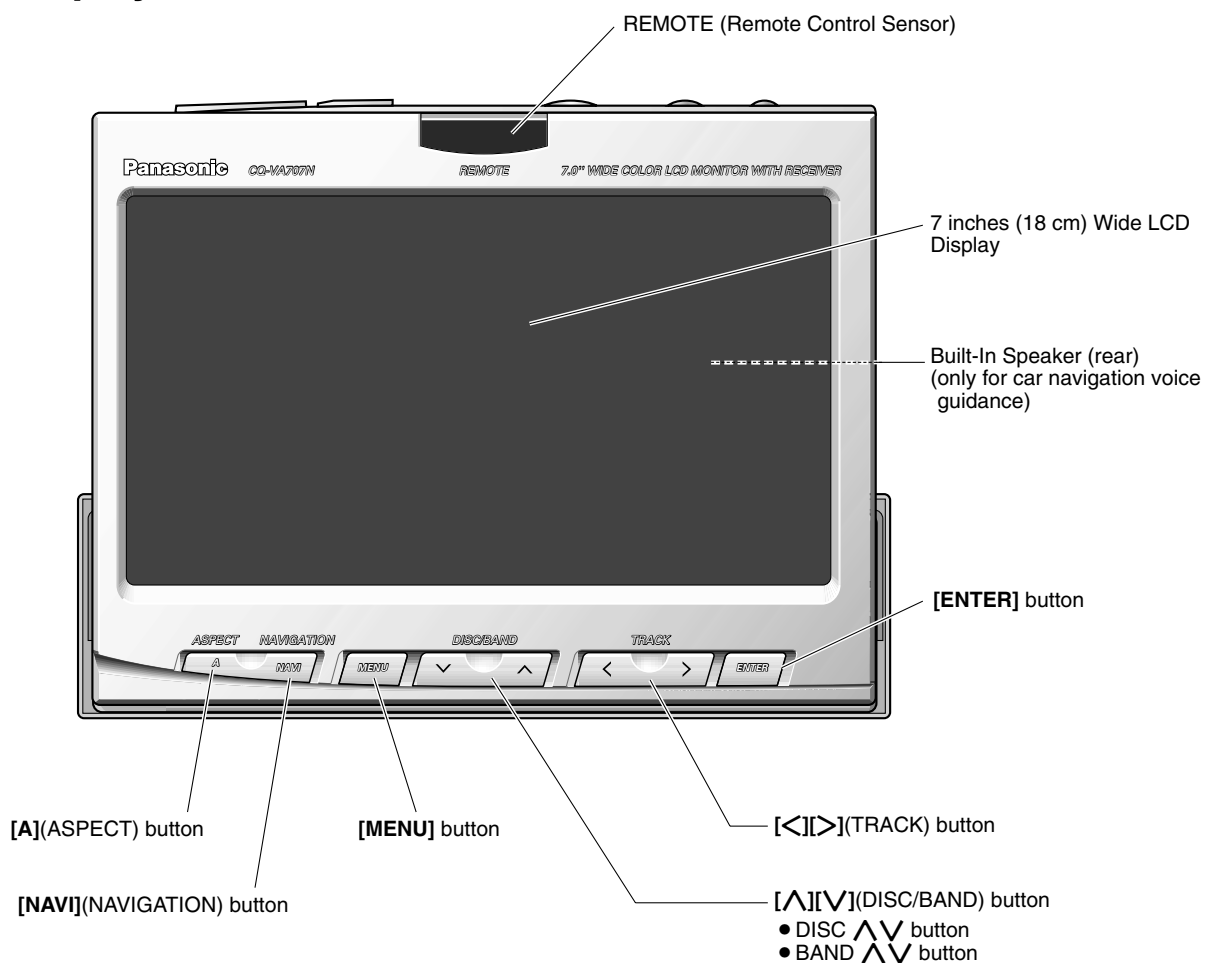

Notes:

- When the display unit is in the retracted position, the [MENU], [NAVI](NAVIGATION), [A](ASPECT) and [TILT] buttons cannot be used.
- When power is on, the indicator of the selected mode lights.

Warning:

For safe driving, the operation is possible only when stopped with the parking brake engaged. "WARNING" will be displayed, if you try to switch to VTR1 or VTR2 mode by pressing the [MODE] button while driving.

Display Unit

Front

Mode Indicator
(AM/FM, VTR1, VTR2, CH•C, TV)
* CH•C : Changer Control

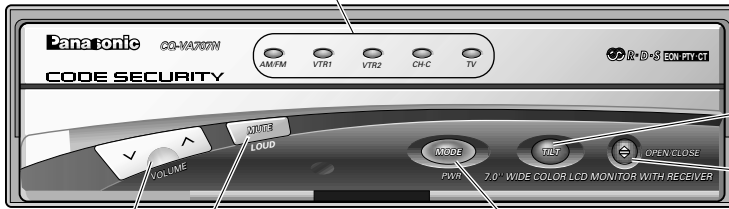

[▲][▼](VOLUME) button

[MUTE](LOUD) button
* Hold down for more than 2 seconds to turn the LOUD on/off.

[MODE](PWR : Power) button
* Hold down for more than 2 seconds to turn the power off.

[TILT] button

[◊](OPEN/CLOSE) button

Rear

See pages 55 to 61 about electrical connections.

Connect the subconnector (parking brake connection lead, reverse lead, antenna control lead, and illumination lead). (⇒ page 55)

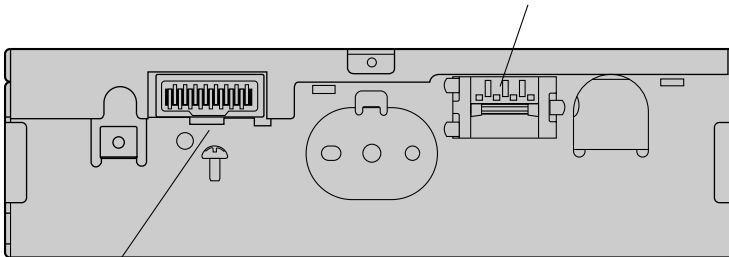

Connect the display unit/control unit connecting cord. (⇒ page 55)

Names of Controls (Continued)

Control Unit

Front

See pages 55 to 61 about electrical connections.

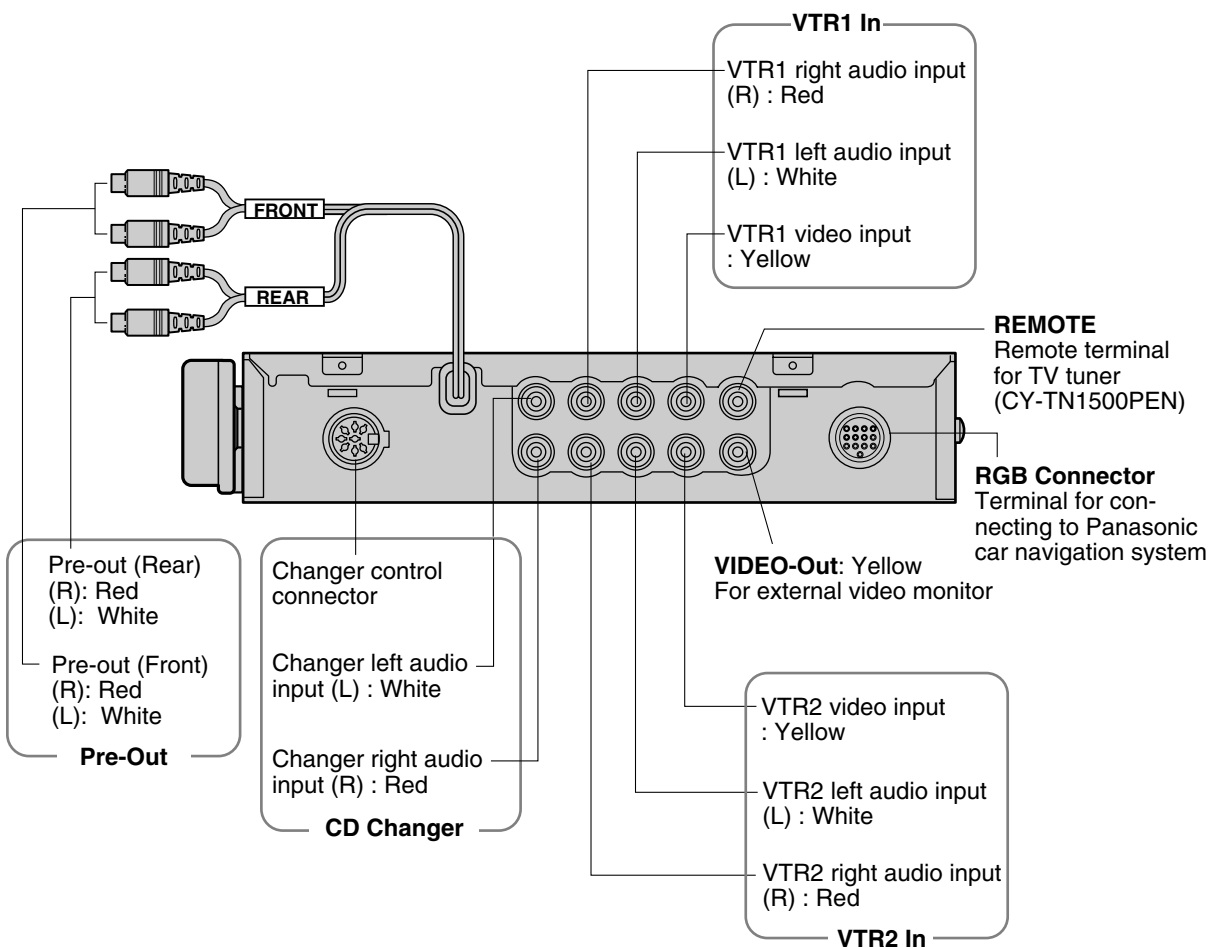

Rear

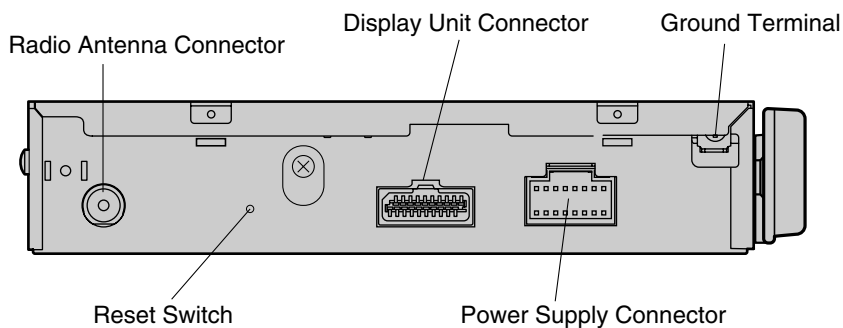

Before Use

Turn the key in the ignition until the accessory indicator lights.

Warning:

Do not insert hands, fingers or foreign objects into the unit while the display is moving. Inserting your hands, fingers or foreign objects into the unit can cause injuries and damage to the unit.

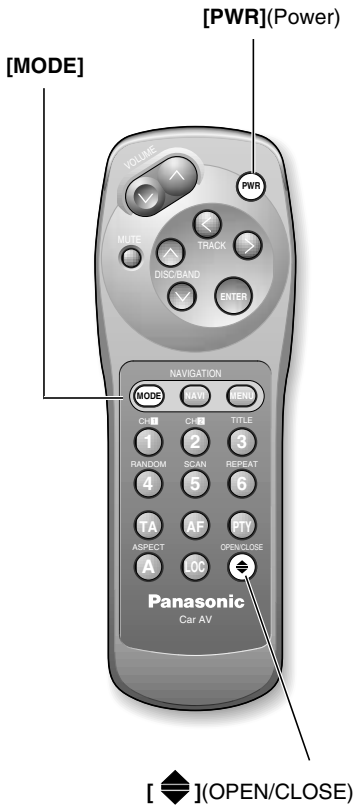

Power on

Press [PWR](Power) or [MODE] to switch on the power.

* When using the display unit, press [MODE](PWR) to switch on the power.

[Default : FM mode]

Power off

Press [PWR] again to switch off the power.

Or, press and hold [MODE] for more than 2 seconds to switch off the power.

* When using the display unit, press and hold [MODE](PWR) for more than 2 seconds to switch off the power.

Caution: If your car has no ACC position, be sure to switch this unit off before stopping the engine.



[MODE] [](OPEN/CLOSE)

How to Open and Raise the Display

Press [](OPEN/CLOSE) to draw out and raise the display.

The display unit is automatically set at the angle and in the position adjusted before. (→ pages 12 and 16)

Note:

When the display unit is opened or closed, a loud beep sounds three times.

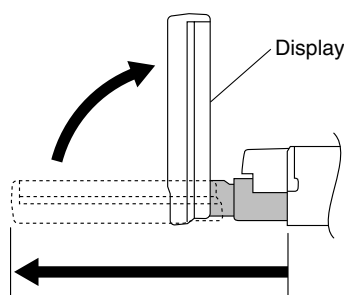

Cautions:

- Mount the unit in a position where it will be free from contact with any obstacle.
- If the unit stops halfway, press [](OPEN/CLOSE) again and draw it all the way in.
- Do not forcibly move it by hand.
- Do not enter your finger or hand into moving parts and disc slot. Otherwise, you and the unit may be damaged. Keep babies and children away from the unit.

Before Use (Continued)



[TILT]

Tilt

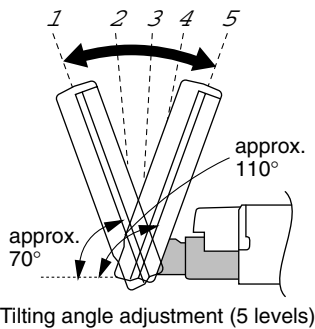

Slide

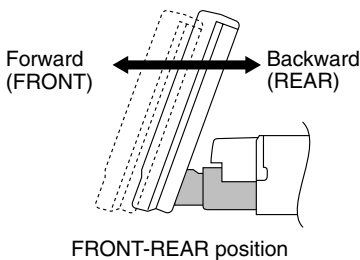

Vertical Angle (TILT) and Forward-Backward Position (SLIDE) Adjustment

The angle adjustment is approximate and may deviate slightly from the set value depending on the installation position and other conditions.
[Default : TILT 3/SLIDE FRONT]

Cautions:

- For smooth adjustment, make sure to first return the lateral angle to the neutral position and then adjust the tilt angle.
- Do not manually change the position of the unit by force.

① After raising the display, press and hold [TILT] on the display unit for more than 1 second to display the monitor position setting menu.

② Press [^] or [v] to adjust the tilting angle.
Press [←] or [→] to move the display to the front or rear position.

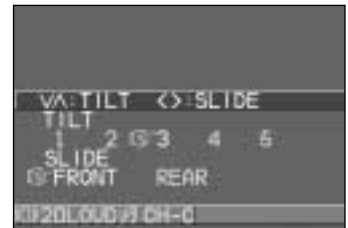

Notes:

- The monitor position setting menu is automatically closed if no operation is performed for about 10 seconds.
- Vertical angle (TILT) and forward-backward position data are saved in the memory, so when the display unit is drawn out next, it is automatically set at the angle and in the position adjusted before.
- The display position can also be set on the menu screen. (→ page 16)

Display Unit Lateral Angle Adjustment

Hold the display unit by the non-slip part in the upper half of it, and adjust its lateral angle.

Non-Slip Part (on the back)

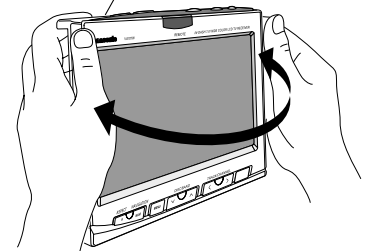
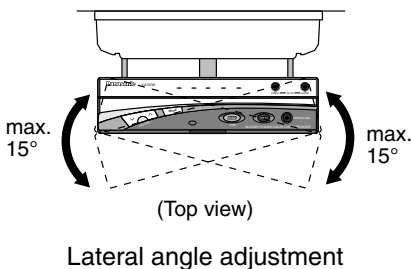

Cautions:

- There is the danger of your fingers being pinched if you hold the unit by the lower part. Hold the unit by the **upper half** of it, and move it carefully without applying an undue force.
- After adjusting its angle, also adjust the brightness to make it easy for you to watch. (→ page 31)

Warning:

Do not insert hands, fingers or foreign objects into the unit while the display is moving. Inserting your hands, fingers or foreign objects into the unit can cause injuries and damage to the unit.

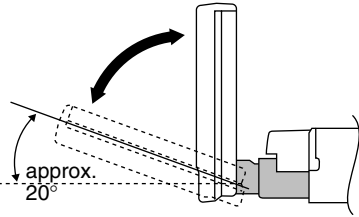

Folding Down the Display Temporarily

Folding down the display unit is convenient for gaining access to the air conditioner controls, for example.

Press **[TILT]** on the display unit to fold down the display unit to 20° from horizontal position.

Press **[TILT]** on the display unit again to raise the display unit.



[TILT] [◆](OPEN/CLOSE)

Caution: Do not place any object on the display unit, or subject it to undue force.

Retracting the Display

① Hold the display unit by its upper portion (with non-slip finish on the back) and return it to the neutral position.



[◆](OPEN/CLOSE)

Return to neutral position

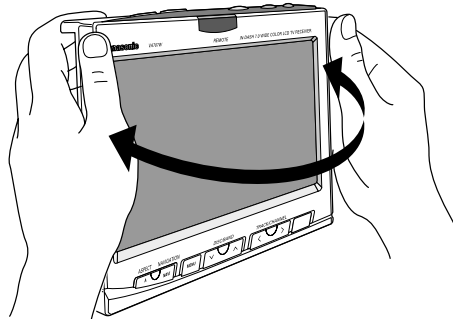

② Press **[◆](OPEN/CLOSE)** to retract the display unit.

Notes:

- When the display unit is opened or closed, a loud beep sounds three times.
- The display unit cannot be retracted if it is not returned to the neutral position. If it is not retracted by pressing the **[◆](OPEN/CLOSE)** button, check again that the unit is back in the lateral neutral position.

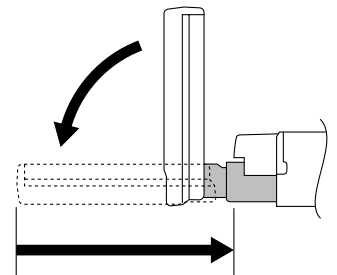

Before Use (Continued)

Using the Menu/Menu Control

Menu Tree

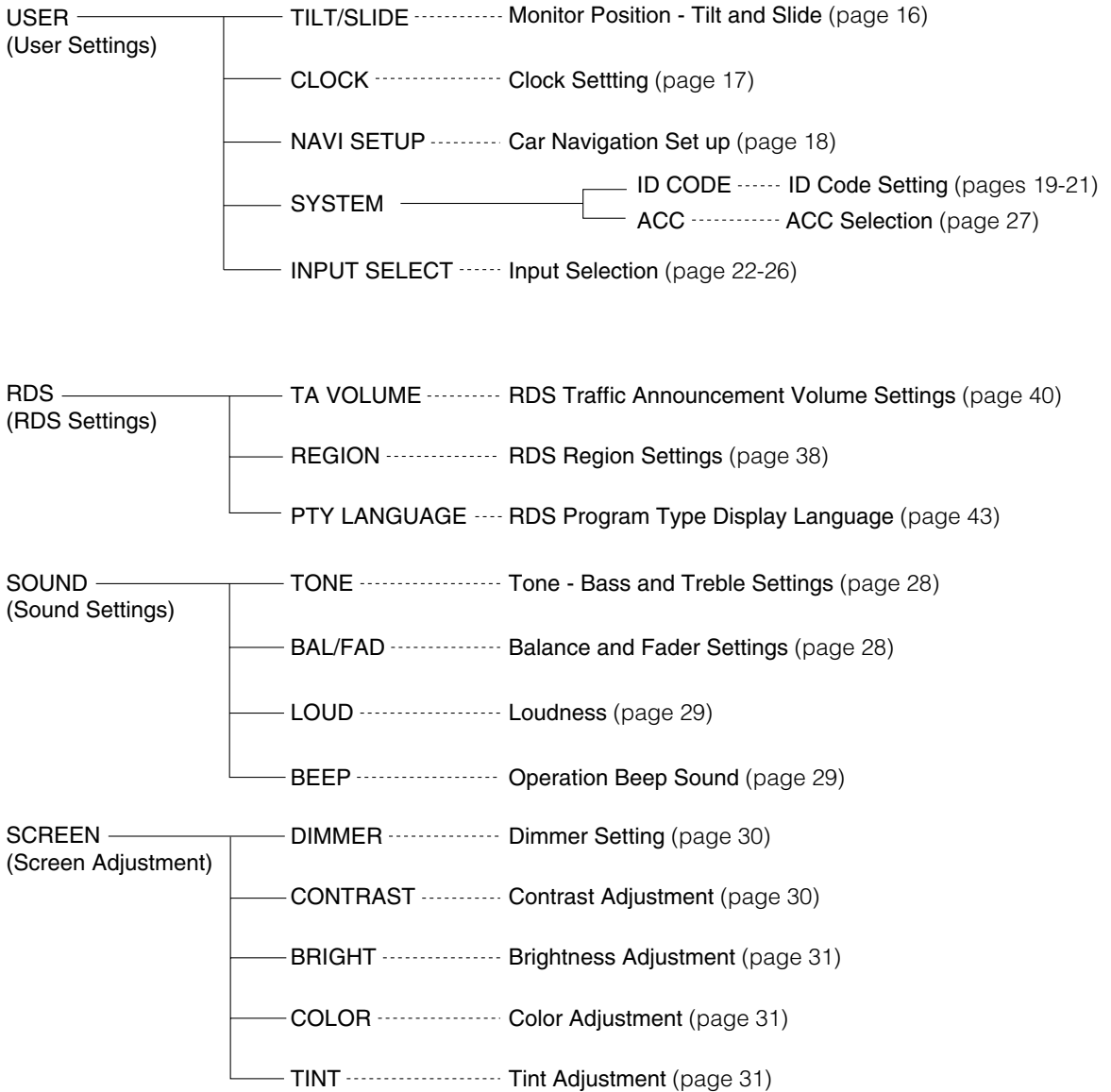

The main menu screen consists of a menu and submenus. Refer to the operation guide shown on the screen.

- ① Press **[MENU]** to display the main menu.

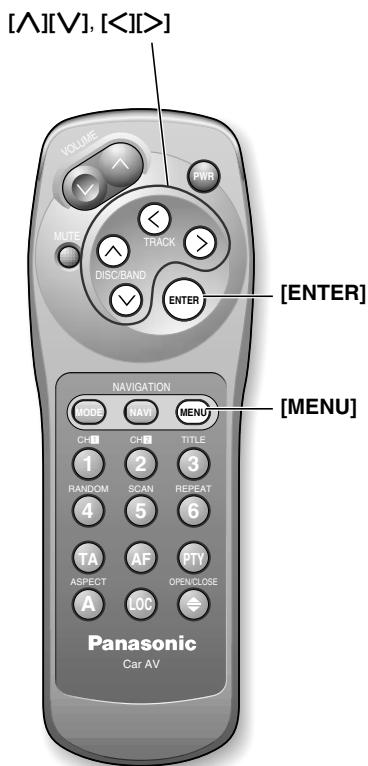

Main Menu

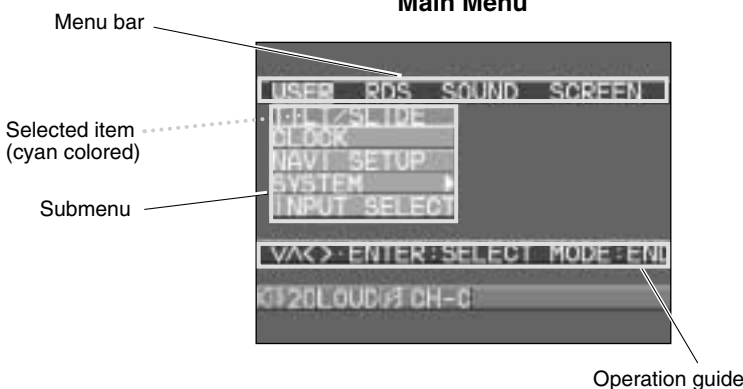

- ② Press the **[^]**, **[v]**, **[<]** or **[>]** button to move the cursor.
- ③ Press **[ENTER]** to select an item.
The setting/adjusting menu for the selected item is displayed.

Note: The RDS menu can be selected only when the radio is in FM mode.

Setting/Adjusting Menu

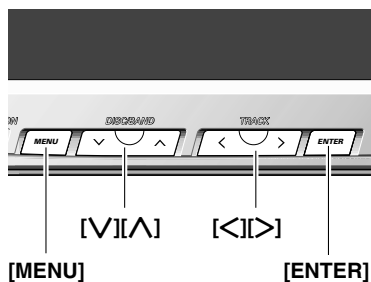
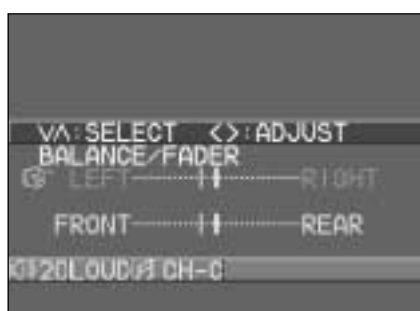

Notes:

- The main menu and the setting/adjusting menu are not displayed when the display unit is in the retracted position.
- Press **[MODE]** to close the main menu and the setting/adjusting menu.

User Settings

Monitor Position (TILT/SLIDE)

Adjust the tilt angle and front/rear position of the raised display unit. [Default: TILT 3/SLIDE FRONT]

* The monitor position setting menu can also be displayed by pressing the [TILT] button on the front panel of the display unit for more than 1 second. (⇒ page 12)

[TILT/SLIDE]

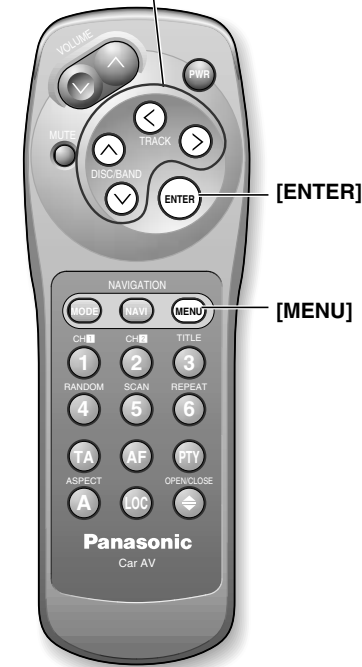

① Press [MENU] to display the menu. Press [←] or [→] to select "USER". Press [↓] or [↑] to select "TILT/SLIDE".



② Press [ENTER] to set "TILT/SLIDE".

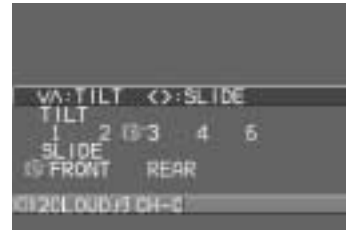

③ **TILT:** Press [↑] or [↓] to increase or decrease the tilt angle of the display unit.

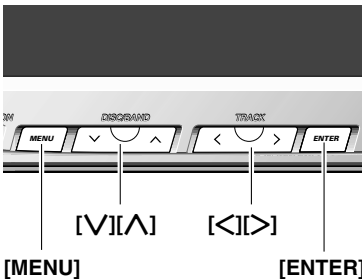
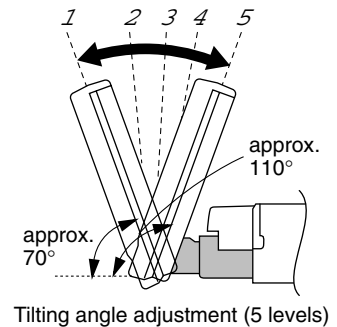

SLIDE: Press [←] or [→] to move the display to the front or rear position.

Note: Position "REAR" and tilt angle "5" cannot be selected at the same time.

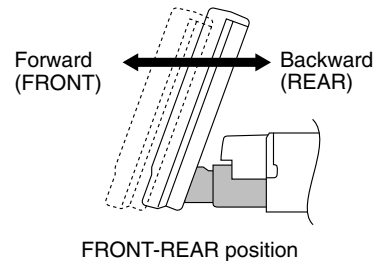

Notes:

- Press [MODE] to close the main menu and the setting/adjusting menu.
- Press [MENU] in the setting/adjusting menu to return to the main menu mode.
- The setting/adjusting menu is automatically closed if no operation is performed for about 10 seconds.

Clock Setting (CLOCK)

- Enable or disable clock the display.
- Adjust the time (24-hour system). [Default: DISPLAY OFF/CLOCK MODE RDS/ADJUST 0:00]

- ① Press **[MENU]** to display the main menu.
Press **[<]** or **[>]** to select "USER". Press **[V]** or **[^]** to select "CLOCK".

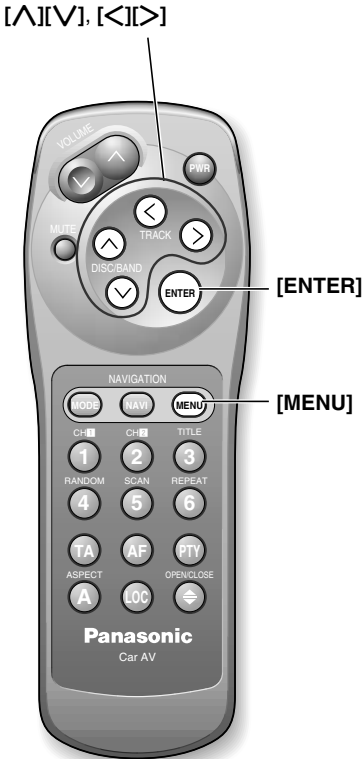

- ② Press **[ENTER]** to set "CLOCK".

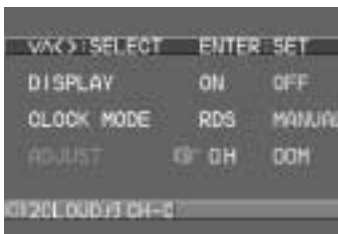

- ③ Press **[<]**, **[>]**, **[V]** or **[^]** to move the cursor. Press **[ENTER]** to set after each setting.

• Clock Display

Select "DISPLAY".
ON: Clock display is on.
OFF: Clock display is off.

• Clock Mode

Select "CLOCK MODE".
RDS: The clock is automatically adjusted using the RDS clock time service function. (⇒ page 36 about RDS)
MANUAL: Adjust the clock manually.
Press **[<]** to adjust the hour.
Press **[>]** to adjust the minute.
Hold **[<]** or **[>]** to change numbers rapidly.

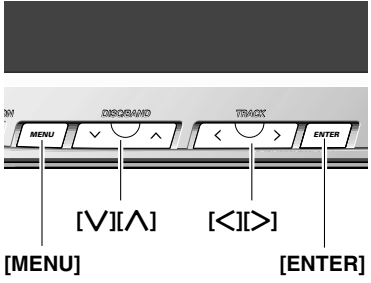

- Notes:**
- Press **[MODE]** to close the main menu and the setting/adjusting menu.
 - Press **[MENU]** in the setting/adjusting menu to return to the main menu mode.
 - The setting/adjusting menu is automatically closed if no operation is performed for about 10 seconds.

User Settings (Continued)

Navigation Set Up (NAVI SET UP)

Navigation volume can be set when a Panasonic car navigation system is connected. This is to set the voice guide volume of the car navigation system. Its volume can be set so that the volume of the unit will be automatically lowered when the voice guide is on (Navi Mute). When navigation input (→ page 22) is set to RGB, connect the unit to the navigation mute cord of the car navigation system.
[Default: NAVI MUTE 1/NAVI VOLUME 4]

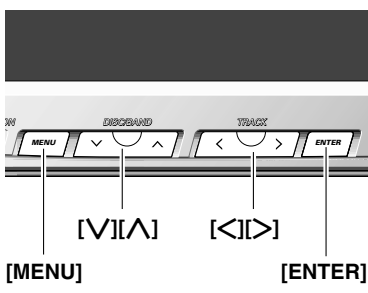
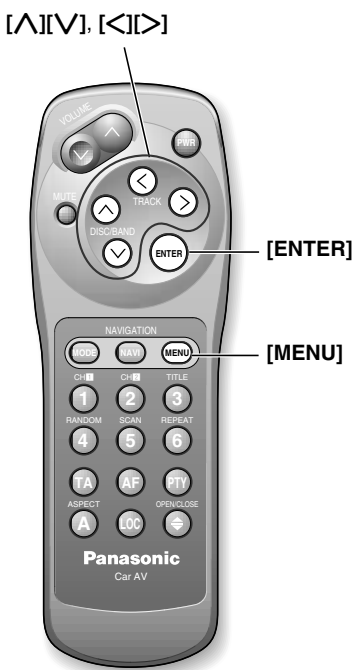

① Press **[MENU]** to display the main menu.
Press **[<]** or **[>]** to select "USER". Press **[V]** or **[^]** to select "NAVI SET UP".



② Press **[ENTER]** to set "NAVI SET UP".



③ Press **[^]**, **[V]**, **[<]** or **[>]** to move the cursor.

- Navi Mute Level
 - OFF: The volume of the unit remains normal even when the voice guide of the car navigation system is on.
* The volume can be adjusted with the VOLUME **[^]** and **[V]** buttons.
 - 1: The volume of the unit is lowered to about 1/3 of the full level when the navigation voice guide is on.
 - 2: The volume of the unit is lowered to about 1/10 of the full level when the navigation voice guide is on.
 - 3: The volume of the unit is lowered to zero (no sound) when the navigation voice guide is on.
- Navigation Volume
 - < : The volume of the navigation voice guide decreases.
 - > : The volume of the navigation voice guide increases.

④ Press **[ENTER]** to complete the navi mute level and the navigation volume level.

- Navi mute is invalid when navigation input (→ page 22) is set to other than RGB, so no item can be selected.
- There is no navigation voice guide output when the display unit is in the retracted position.

Notes:

- Press **[MODE]** to close the main menu and the setting/adjusting menu.
- Press **[MENU]** in the setting/adjusting menu to return to the main menu mode.
- The setting/adjusting menu is automatically closed if no operation is performed for about 10 seconds.

ID Code (ID-CODE) Setting

Prior to operating this unit, it is advisable to assign your 4-digit ID code for security. (The figures **1 to 6 can be used**. The figures 7 to 9 and 0 are not available. Make sure to use **four digits** for ID code. ID code can not be set with two or three digits.)

Once the ID code has been set, the unit cannot be operated if the main power supply is disconnected then re-connected. It is electronically locked up so that the thief could not use the stolen unit unless that person knows the code you have set.

The ID code operation must be performed only by the person whom the unit belongs to.

Generally, it is not necessary to enter the ID code each time when using the unit if it has never been disconnected from the main power supply (car battery).

Caution:

Record your registered ID code and keep it in a secure location. If you forget it, you will be unable to use the unit.

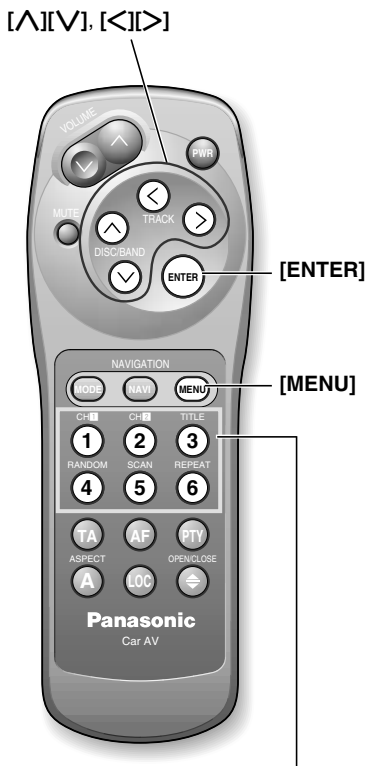

Numeric button

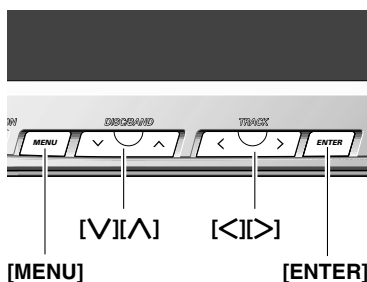

How to enter your ID code (For the first time)

- 1 Press [MENU] to display the main menu. Press [<] or [>] to select "USER". Press [^] or [v] to select "SYSTEM" and "ID-CODE".

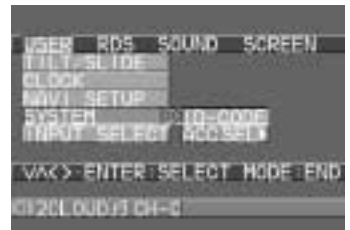

- 2 Press [ENTER] to set "ID-CODE". The ID code setting menu appears.

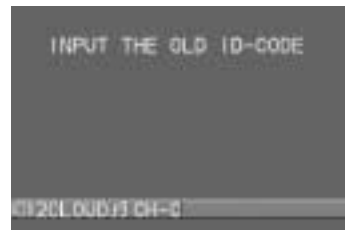

Note: When you are setting your ID code for the first time, it is not necessary to enter the old ID code.

- 3 Enter an ID code of 4 digits using the buttons [1] to [6]. (Only for remote control)

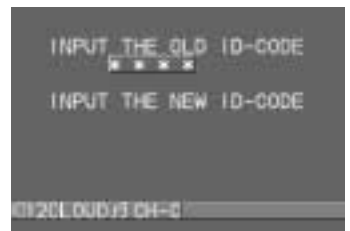

- 4 Enter the new ID code of 4 digits again using the buttons [1] to [6]. (Only for remote control)

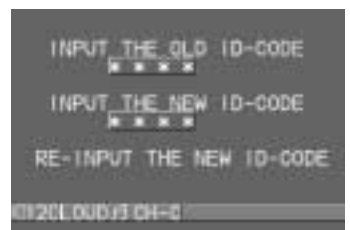

Caution: Record your registered ID code and keep it in a secure location.

User Settings (Continued)

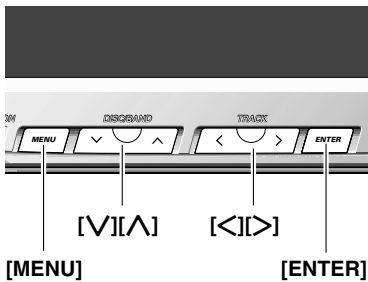
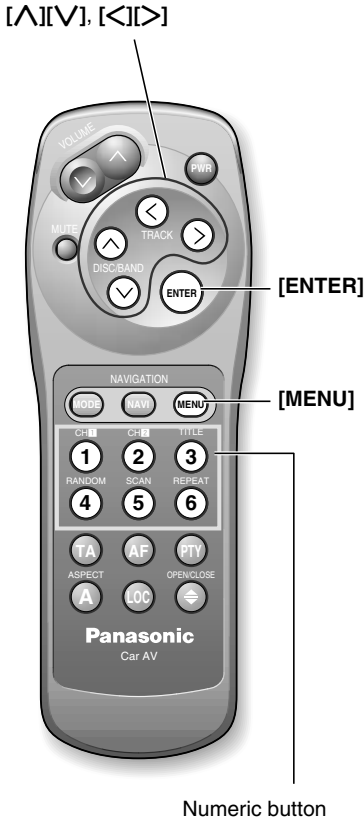

How to change your ID code

If you wish to change your already set ID code for a new ID code, follow the steps below.

- ① Press **[MENU]** to display the main menu.
Press **[<]** or **[>]** to select "USER".
Press **[^]** or **[v]** to select "SYSTEM" and "ID-CODE".
- ② Press **[ENTER]** to set "ID-CODE".
The ID code setting menu appears.
- ③ Enter the present ID code using the buttons **[1]** to **[6]**. (Only for remote control)
If the wrong ID code is entered, a new ID code cannot be registered.
- ④ Enter a new ID code of 4 digits using the buttons **[1]** to **[6]**. (Only for remote control)
- ⑤ Enter the new ID code of 4 digits again using the buttons **[1]** to **[6]**. (Only for remote control)

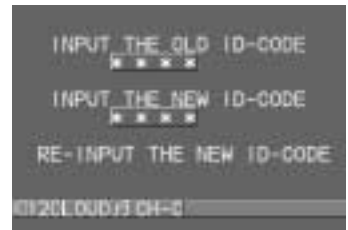
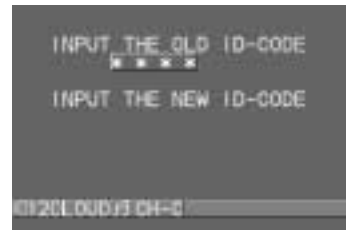
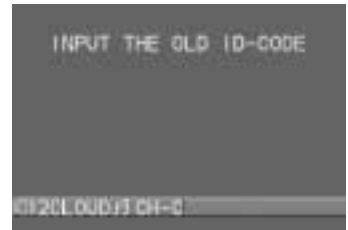
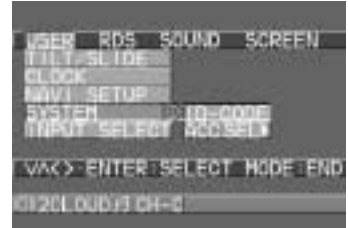

Caution:

Record your registered ID code and keep it in a secure location.

How to cancel the known ID code

Note: Should your unit ever require service, cancel your ID-Code before sending for repair.

Perform ① - ③.

"INPUT THE NEW ID-CODE" is displayed, but please ignore it.

- ④ Press and hold **[ENTER]** until display the "RE-INPUT THE NEW ID-CODE".

The ID code canceling procedure is completed. The unit now works like any other radio without an ID-CODE.

Notes:

- Press **[MODE]** to close the main menu and the setting/adjusting menu.
- Press **[MENU]** in the setting/adjusting menu to return to the main menu mode.
- The setting/adjusting menu is automatically closed if no operation is performed for about 10 seconds.

ID Code Input

- When removing the unit from the car and mounting it on another car,
- When replacing a car battery with a new one, or other cases

When the unit is disconnected from the main power supply such as the above cases, follow the procedure below.

Note: All settings return to the default setting **except ID code.**

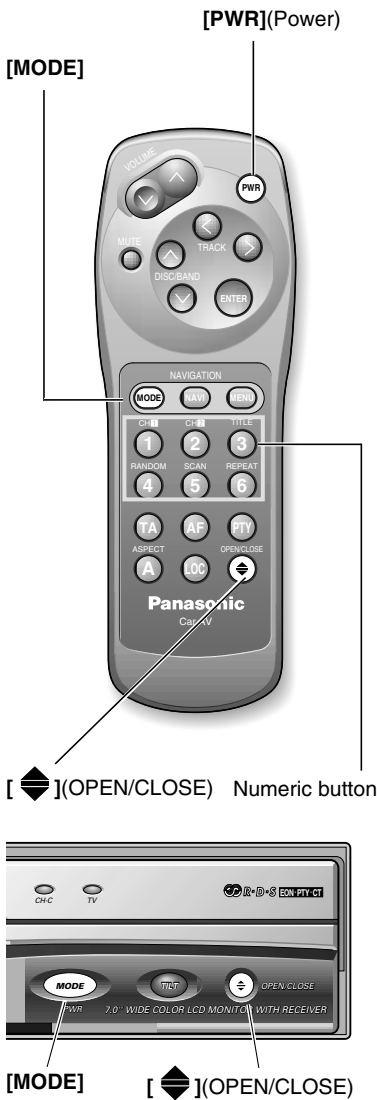

- ① Press **[PWR]** or **[MODE]** to switch on the power.
* When using the display unit, press **[MODE](PWR)** to switch on the power.
The loud beep sounds for 10 seconds.
- ② Press **[OPEN/CLOSE]** to raise the display unit during the loud beep is sounding.
* The display unit is not raised even if you press **[OPEN/CLOSE]** after the loud beep stops. In such a situation, switch off the power and try the procedure again.
- ③ ID code input screen is displayed. Enter the ID code using the remote control.



success →



Note: When failing in entering ID code, a screen on the right is displayed, and the unit beeps three times. Enter a correct ID code. In case of failing in entering ID code three times consecutively, the power is turned off. Turn on the power again and enter a correct ID code in this case.



Notes:

- Press **[MODE]** to close the main menu and the setting/adjusting menu.
- Press **[MENU]** in the setting/adjusting menu to return to the main menu mode.
- The setting/adjusting menu is automatically closed if no operation is performed for about 10 seconds.

User Settings (Continued)

Input Selection (INPUT SELECT)

The unit has three connecting terminals: RGB, VTR1 VTR2. A car navigation system, rear-view camera, television tuner, etc. can be connected to these terminals. Use this menu to set the device actually connected to each terminal. [Default : NAVI RGB/CAMERA OFF/TV TUNER OFF/VTR1 PAL/VTR2 PAL]

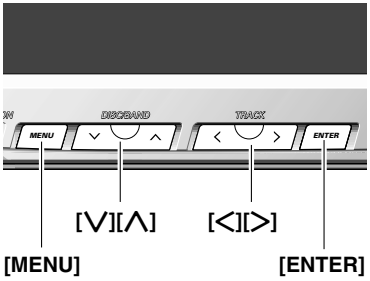
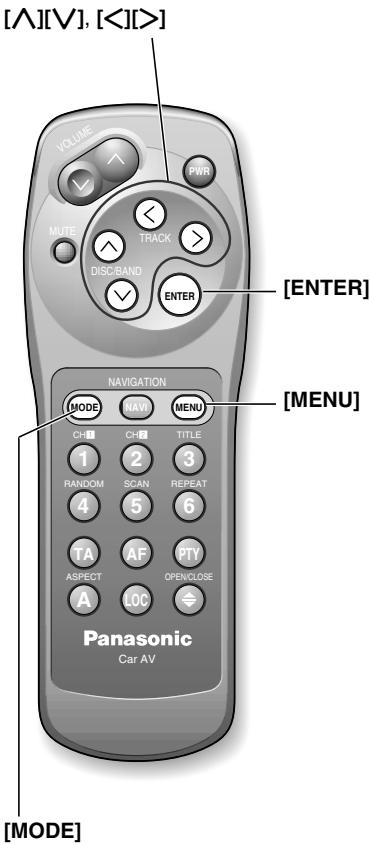

① Press **[MENU]** to display the main menu.
Press **[<]** or **[>]** to select "USER".
Press **[V]** to select "INPUT SELECT".



② Press **[ENTER]** to set "INPUT SELECT".



③ Press **[V]**, **[^]**, **[<]** or **[>]** to move the cursor. Press **[ENTER]** to set after each setting.

- NAVI:** Set the terminal to which a Panasonic car navigation system (CN-DV2000EN, for example) is connected. (It is recommended that a car navigation system be connected to the RGB terminal.) If no car navigation system is connected, select RGB.
- CAMERA:** Set the terminal to which a rear-view camera is connected. If no rear-view camera is connected, select OFF.
- TV TUNER:** Set the terminal to which a TV tuner (CY-TN1500PEN, for example) is connected. If no TV tuner is connected, select OFF.

④ If needed, set PAL or NTSC for VTR1 and VTR2.

Note: If the terminal is set as a TV tuner, the TV mode is automatically set to PAL, and NTSC is not available.

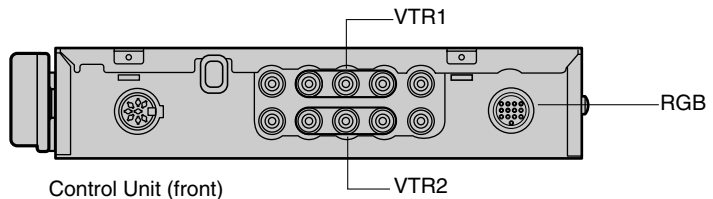

Connection example

See pages 55 to 61 about electrical connections for detail.

Panasonic Car Navigation System (CN-DV2000EN)

Connect to RGB connector.

When using DVD Player of CN-DV2000EN, **connect to VTR1.**

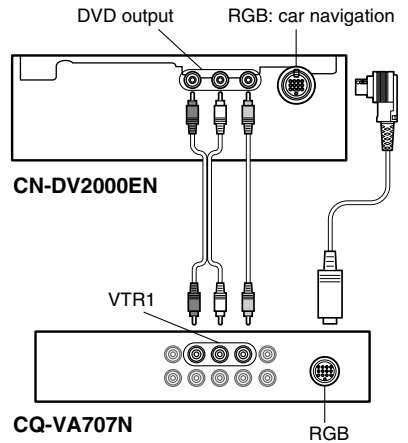
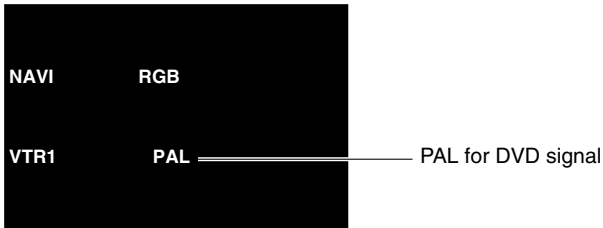

Note on connecting a car navigation system

• RGB connection

It is recommended that Panasonic car navigation system be connected to the RGB terminal. If a car navigation system is connected to another than the RGB terminal (VTR1 or VTR2), set the navigation screen to NTSC. To watch a DVD video of the PAL system with the car navigation system, change the setting to PAL on this menu.

• RCA cord

It is recommended that the VTR output (RCA cord) of a car navigation system be connected to VTR1. If a DVD video disc is inserted in this case, the VTR1 DVD video mode is automatically selected (provided that the video control cord is connected) (→ page 57).

Other corporations' car navigation system

Connect to VTR1 or VTR2.

VTR1

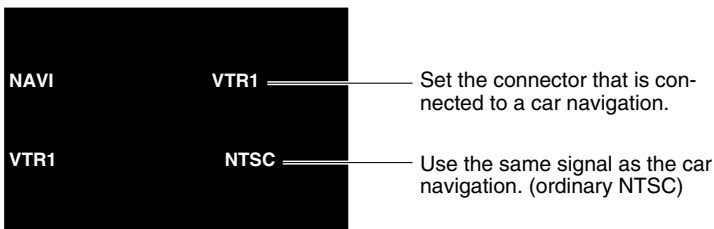

Other corporations' car navigation system

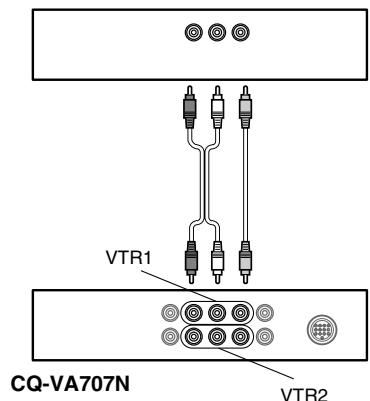

User Settings (Continued)

Rear View Camera

Connect to a video input of VTR1 or VTR2.

VTR1



Set the connector that connected to a rear view camera.

Use the same signal as the rear view camera. (ordinary PAL)

Rear View Camera

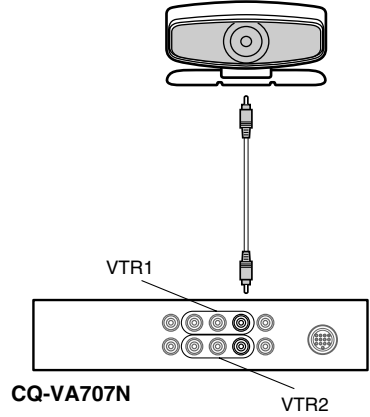

TV Tuner (CY-TN1500PEN)

Connect to VTR1 or VTR2.

VTR1

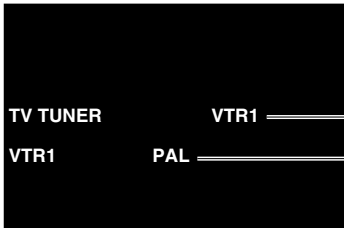

Set the connector that is connected to TV tuner.

If the terminal is set as a TV tuner, the TV mode is automatically set to PAL, and NTSC is not available.

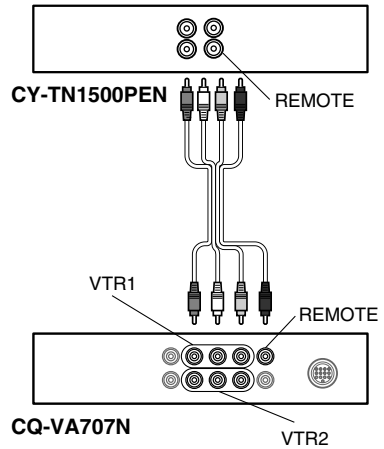

Others equipment such as video camera

Connect to VTR1 or VTR2.

Example: When connecting a PAL-signal video to VTR1

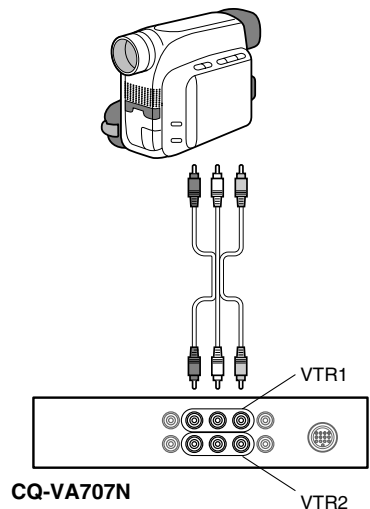
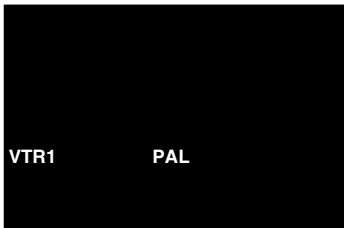

Example of connecting to two or more products

Panasonic Car Navigation System (CN-DV2000EN) and TV Tuner (CY-TN1500PEN)

- Car Navigation (CN-DV2000EN) ——— RGB
- DVD Player (CN-DV2000EN) ——— VTR1
- TV Tuner (CY-TN1500PEN) ——— VTR2

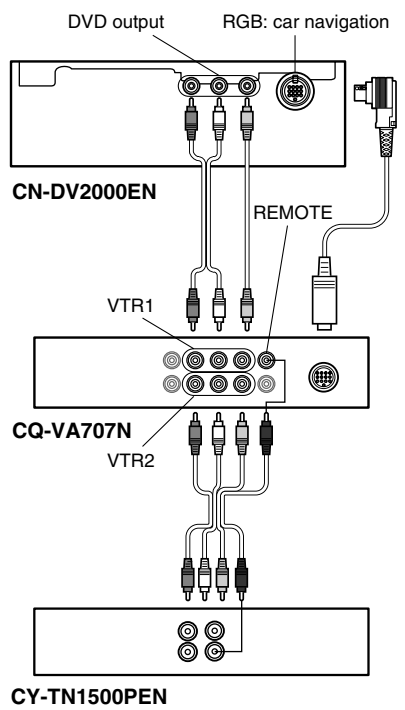
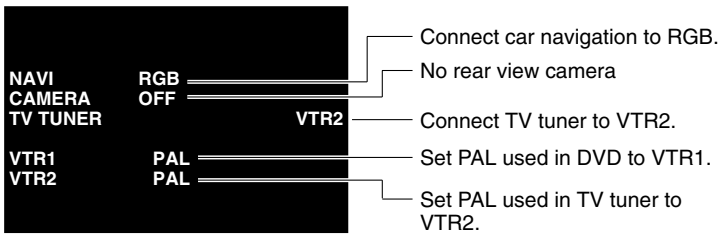

Panasonic Car Navigation System (CN-DV2000EN), TV Tuner (CY-TN1500PEN) and Rear View Camera (DVD Player of CN-DV2000EN is not used.)

- Car Navigation (CN-DV2000EN) ——— RGB
- TV Tuner (CY-TN1500PEN) ——— VTR1
- Rear View Camera ——— VTR2

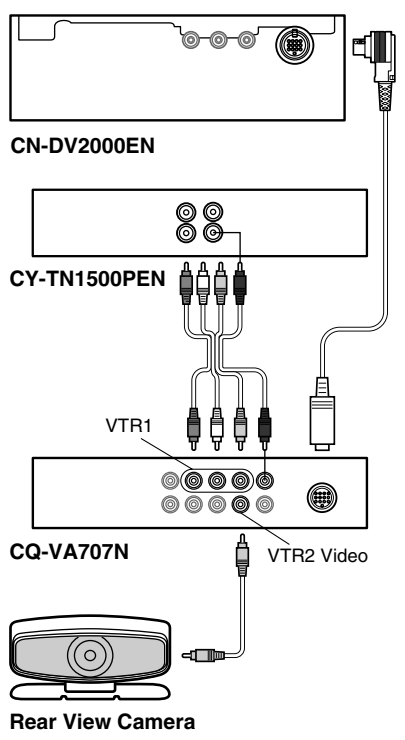
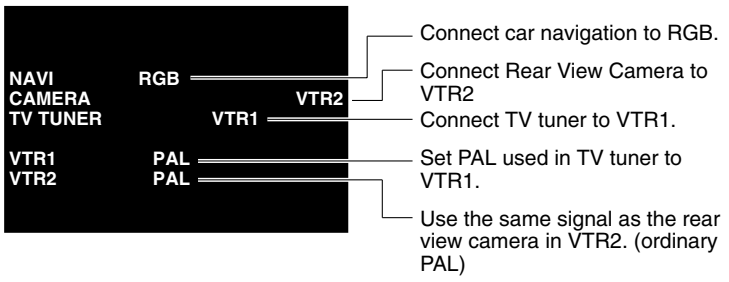

User Settings (Continued)

TV Tuner (CY-TN1500PEN) and Rear View Camera (a car navigation system is not connected.)

TV Tuner (CY-TN1500PEN) ————— VTR1
Rear View Camera ————— VTR2

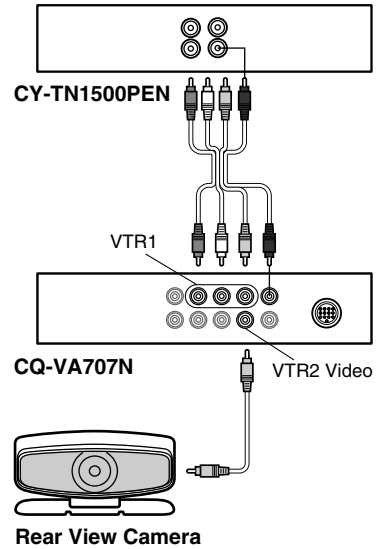
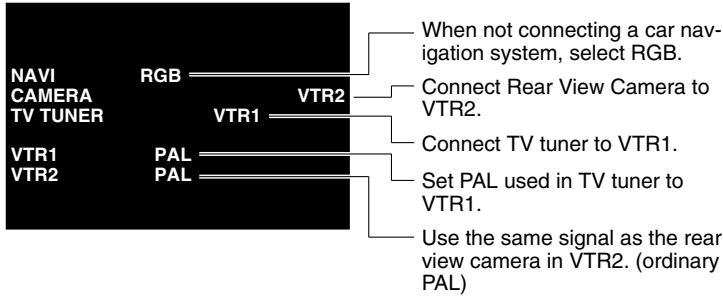

Other corporations' car navigation system and TV Tuner (CY-TN1500PEN)

Car Navigation ————— VTR1
TV Tuner (CY-TN1500PEN) ————— VTR2

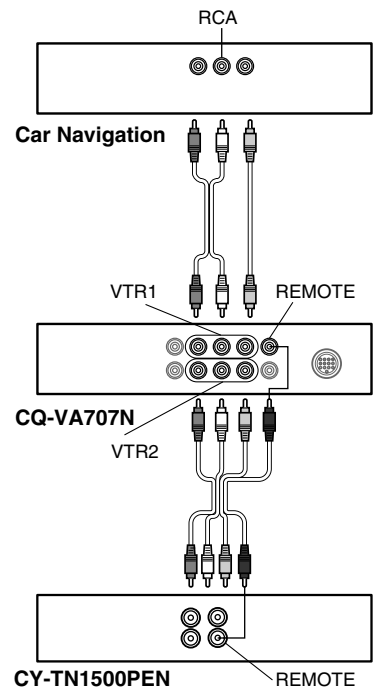
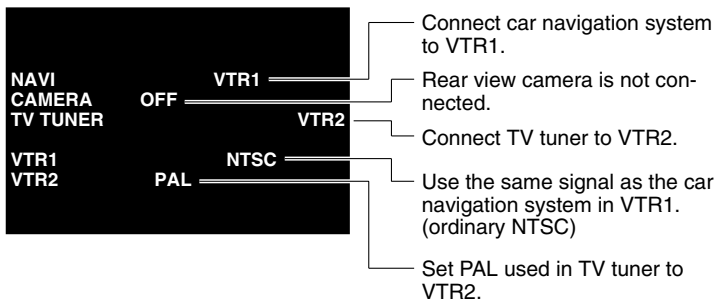

Notes:

- Press [MODE] to close the main menu and the setting/adjusting menu.
- Press [MENU] in the setting/adjusting menu to return to the main menu mode.
- The setting/adjusting menu is automatically closed if no operation is performed for about 10 seconds.

ACC Selection (ACC)

If your car has an ACC position, turn the switch to ACC. Otherwise, turn it to OFF. When ACC ON is set, the unit is turned off automatically after stopping the engine.
 If your car is not equipped with ACC, be sure to turn off the unit before stopping the engine. Otherwise, the unit keeps consuming the power. Consequently, the battery goes dead. [Default: ACC OFF]

Caution:
 If your car has no ACC, be sure to use a default, ACC OFF.

[▲][V], [◀][▶]

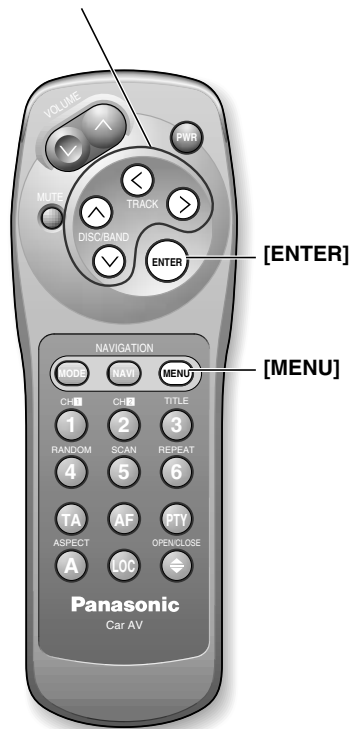

- ① Press **[MENU]** to display the main menu.
 Press **[◀]** or **[▶]** to select "USER". Press **[V]** or **[▲]** to select "SYSTEM" and "ACC".

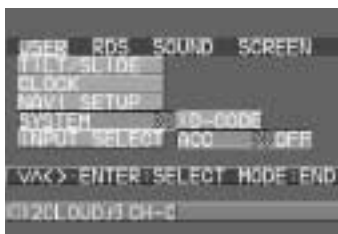

- ② Press **[ENTER]** to switch the ACC Selection as follows.

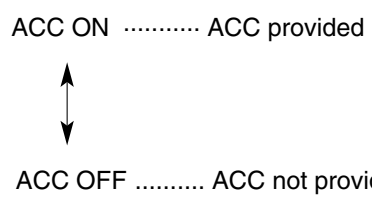

Caution: If your car has no ACC, be sure to switch this unit off before stopping the engine.

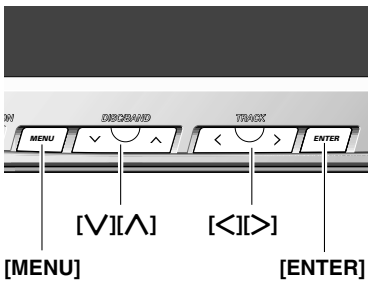

Merits when ACC is activated:

- The unit is turned off automatically after stopping the engine.
- The **[MODE]** button on the front of the display unit remains lit even when power is off.
- Even if the power is off, the display unit can be tilted by pressing **[TILT]** button.

Notes:

- Press **[MODE]** to close the main menu and the setting/adjusting menu.
- Press **[MENU]** in the setting/adjusting menu to return to the main menu mode.
- The setting/adjusting menu is automatically closed if no operation is performed for about 10 seconds.

Sound Settings

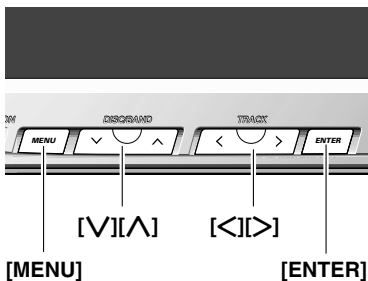
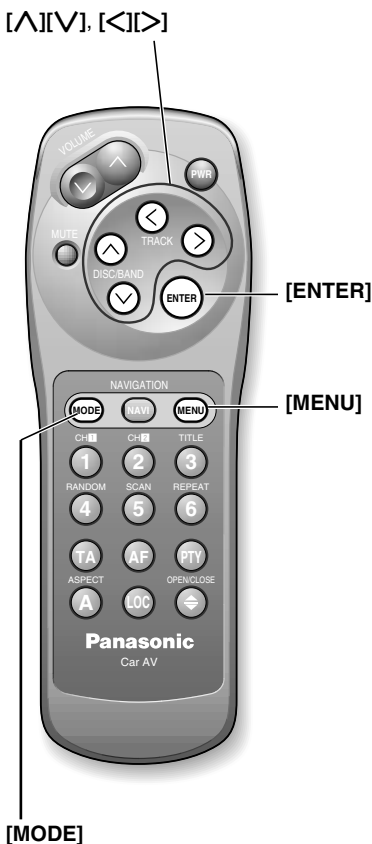

Tone - Bass/Treble

Emphasize or de-emphasize bass/treble level.

[Default: 0 dB, adjustment range: -12 dB to +12 dB]

- ① Press **[MENU]** to display the main menu.
Press **[<]** or **[>]** to select "SOUND".
Press **[V]** or **[^]** to select "TONE".
- ② Press **[ENTER]** to set "TONE".
- ③ Press **[V]** or **[^]** to select "BASS" or "TREBLE".
Press **[<]** or **[>]** to decrease or increase the level.

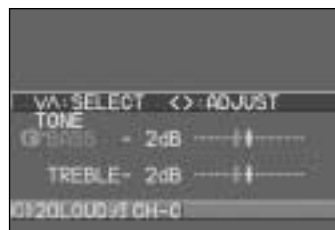
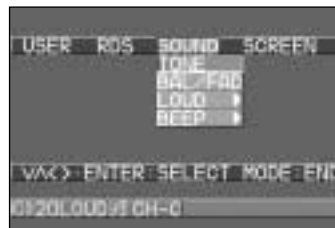

Balance/Fader

Adjust the sound volume between the right and left speakers (BALANCE) and the front and rear speakers (FADER).

[Default: Center position]

- ① Press **[MENU]** to display the main menu.
Press **[<]** or **[>]** to select "SOUND". Press **[V]** or **[^]** to select "BAL/FAD".
- ② Press **[ENTER]** to set "BAL/FAD".
- ③ Press **[^]** or **[V]** to select BALANCE or FADER.
 - Press **[<]** or **[>]** to shift the sound volume to the left or right speakers when selecting BALANCE (L – R).
 - Press **[<]** or **[>]** to shift the sound volume to the front or rear speakers when selecting FADER (FRONT – REAR).

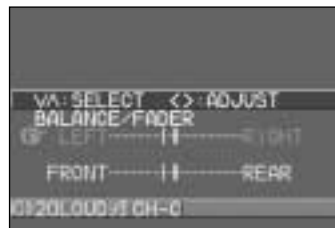

Notes:

- Press **[MODE]** to close the main menu and the setting/adjusting menu.
- Press **[MENU]** in the setting/adjusting menu to return to the main menu mode.
- The setting/adjusting menu is automatically closed if no operation is performed for about 10 seconds.

Loudness

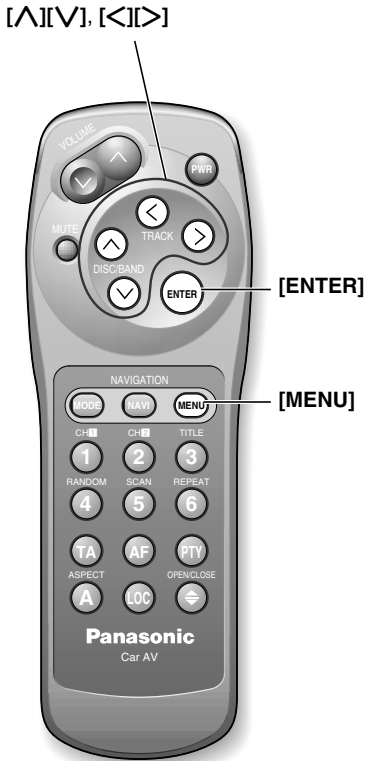

Enhance treble and bass tones when listening at low or medium volume. [Default: ON]

- 1 Press **[MENU]** to display the main menu.
Press **[<]** or **[>]** to select "SOUND". Press **[V]** or **[^]** to select "LOUD".



- 2 Press **[ENTER]** to switch the loudness as follows.

LOUD ON \longleftrightarrow LOUD OFF

Note: The loudness setting can be switched between ON and OFF by pressing and holding **[MUTE](LOUD)** on the main unit for more than 2 seconds.

Beep

Enable or disable the beep of button operations. [Default: ON]

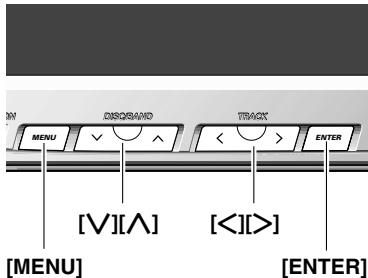

- 1 Press **[MENU]** to display the main menu.
Press **[<]** or **[>]** to select "SOUND". Press **[V]** to select "BEEP".

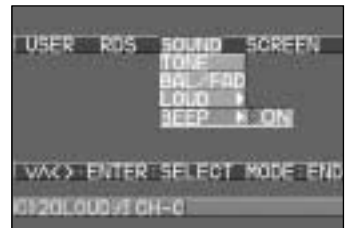

- 2 Press **[ENTER]** to switch the beep of button operations as follows.

BEEP ON \longleftrightarrow BEEP OFF

Note: When the display unit is opened or closed, a loud beep sounds three times. However, this loud beep has nothing to do with BEEP ON/OFF. Accordingly, the loud beep sounds even if BEEP OFF has been set.

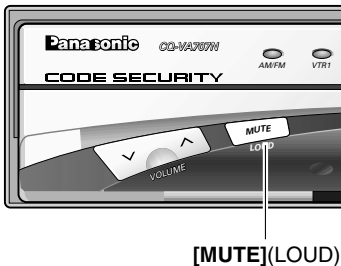

Notes:

- Press **[MODE]** to close the main menu and the setting/adjusting menu.
- Press **[MENU]** in the setting/adjusting menu to return to the main menu mode.
- The setting/adjusting menu is automatically closed if no operation is performed for about 10 seconds.

Screen Adjustment

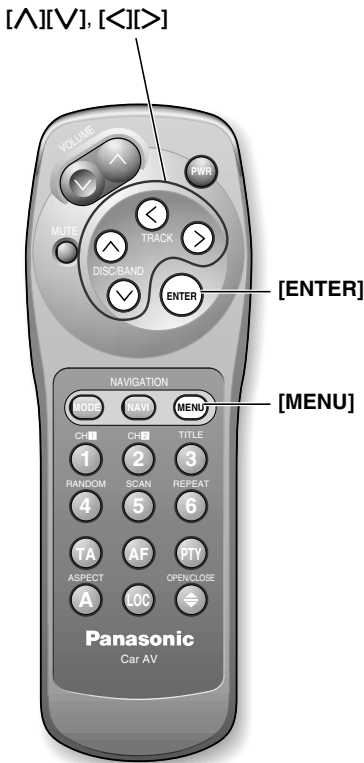

Dimmer

Adjust the brightness of the backlight.

[Default: DAY 4
NIGHT 1]

- ① Press **[MENU]** to display the main menu.
Press **[<]** or **[>]** to select "SCREEN".
Press **[^]** to select "DIMMER".
- ② Press **[ENTER]** to set "DIMMER".
- ③ Press **[^]**, **[v]**, **[<]** or **[>]** to move the cursor. Press **[ENTER]** to set after each setting.
DAY: With the side lights off
NIGHT: With the side lights on
> : To increase light intensity
< : To decrease light intensity

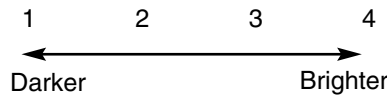
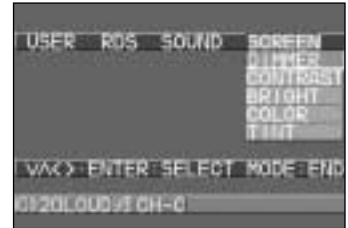

Contrast

Adjust the image contrast.

[Default: 0, adjustment range: -15 to +15]

- ① Press **[MENU]** to display the main menu.
Press **[<]** or **[>]** to select "SCREEN". Press **[v]** or **[^]** to select "CONTRAST".
- ② Press **[ENTER]** to set "CONTRAST".
- ③ Press **[<]** or **[>]** to increase or decrease the contrast between black and white.

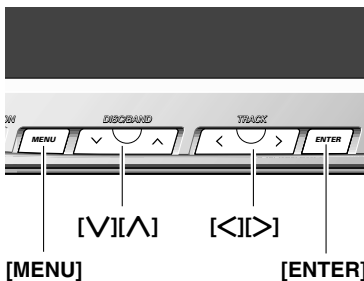

Notes:

- Press **[MODE]** to close the main menu and the setting/adjusting menu.
- Press **[MENU]** in the setting/adjusting menu to return to the main menu mode.
- The setting/adjusting menu is automatically closed if no operation is performed for about 10 seconds.

Brightness

Adjust the image brightness.
 [Default: 0, adjustment range: -15 to +15]

- ① Press **[MENU]** to display the main menu.
 Press **[<]** or **[>]** to select "SCREEN".
 Press **[V]** or **[^]** to select "BRIGHT".
- ② Press **[ENTER]** to set "BRIGHT".
- ③ Press **[<]** or **[>]** to darken or lighten the display.

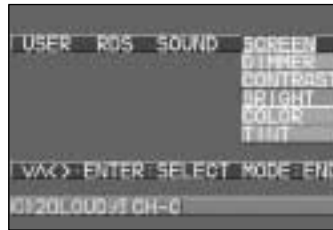
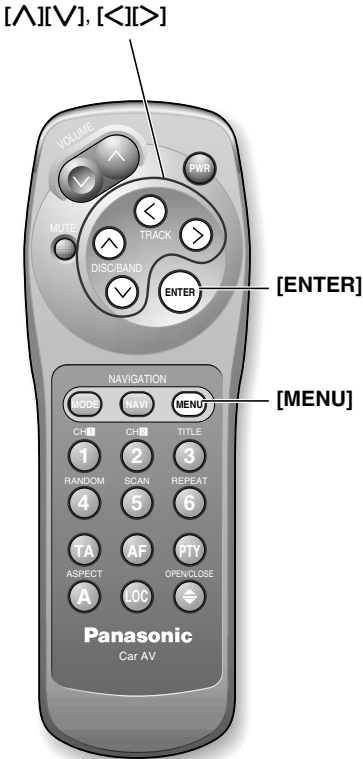

Color

Adjust the image color depth.
 [Default: 0, adjustment range: -15 to +15]

- ① Press **[MENU]** to display the main menu.
 Press **[<]** or **[>]** to select "SCREEN". Press **[V]** or **[^]** to select "COLOR".
- ② Press **[ENTER]** to set "COLOR".
- ③ Press **[<]** or **[>]** to lighten or deepen the depth of color on the display.



Tint

Adjust the image color tone or tint.
 [Default: 0, adjustment range: -15 to +15]

Note: Tint cannot be set on the PAL setting screen.

- ① Press **[MENU]** to display the main menu.
 Press **[<]** or **[>]** to select "SCREEN". Press **[V]** to select "TINT".
- ② Press **[ENTER]** to set "TINT".
- ③ Press **[<]** or **[>]** to emphasize red or green in the color image.

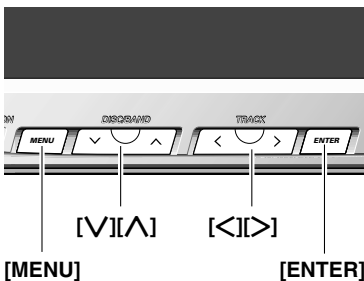

Notes:

- Press **[MODE]** to close the main menu and the setting/adjusting menu.
- Press **[MENU]** in the setting/adjusting menu to return to the main menu mode.
- The setting/adjusting menu is automatically closed if no operation is performed for about 10 seconds.

Operation: General

[▲][▼](VOLUME)



Volume

Press [▲] or [▼] to increase or decrease the volume.

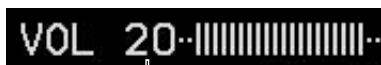

Volume Level 0 to 40

Press and hold [▲] or [▼] for more than 2 seconds to sequentially change the numeric levels on the display.

* The volume adjusted in each mode is stored in the memory, and changes each time the mode is changed. (Intelligent volume function)

Note:

Adjust the volume while the volume indicator appears on the display.

Mute

- Press [MUTE] to mute the sound completely.



- Press [MUTE] again to cancel.

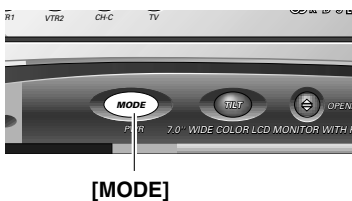
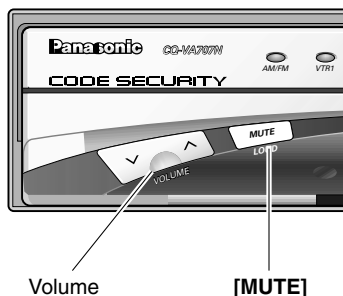

Changing the Operation Mode

Press [MODE] to change the operation mode as follows.

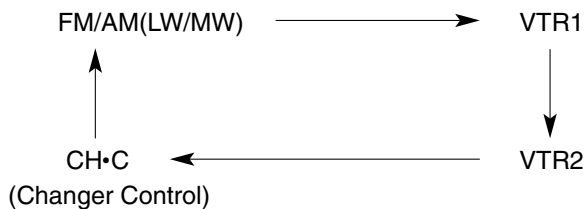

Mode Indicator





Notes:

- In VTR1 mode, the external device connected to VTR1-IN on the front of the control unit outputs its video and audio signals. (➔ page 48)
- In VTR2 mode, the external device connected to VTR2-IN on the front of the control unit outputs its video and audio signals. (➔ page 48)
- CH•C (changer control) mode is not available if no changer is connected.
- If the navigation mode is ON, only the audio signal is switched while the video signal remains as it is.
- The mode can be changed even when the display unit is in the retracted position.

Displaying the Car Navigation Screen

A Panasonic car navigation system must be connected. This function allows a parallel operation. While you follow the Navigation Screen, you can listen to radio/CD changer/VTR1/VTR2 mode in background.

- Press **[NAVI](NAVIGATION)** to change to the car navigation mode.
- Press **[NAVI](NAVIGATION)** again to cancel.

Caution:

When a car navigation system is connected to this unit, the correct navigation input setting is necessary. (➔ page 22)

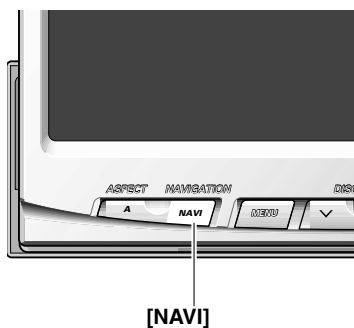

Notes:

- If the navigation mode is ON, only the audio signal is switched while the video signal remains as it is.
- The volume of the voice guidance from the car navigation system and the volume of the main unit (radio/CD changer/VTR1/VTR2) can be set. (➔ page 18)

Radio Basics

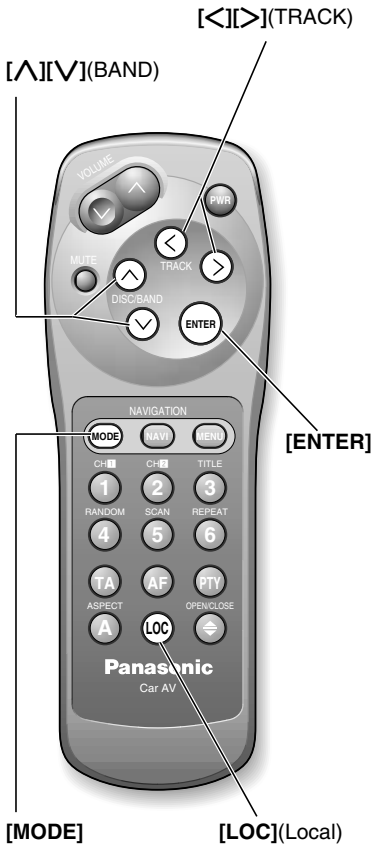

Radio Mode

Press **[MODE]** to select the FM/AM(LW/MW) mode as follows.



Notes:

- If the navigation mode is ON, only the audio signal is switched while the video signal remains as it is.
- The mode can be changed even when the display unit is in the retracted position.
- The **[MODE]** button on the front of the display unit remains lit even when the power is off.

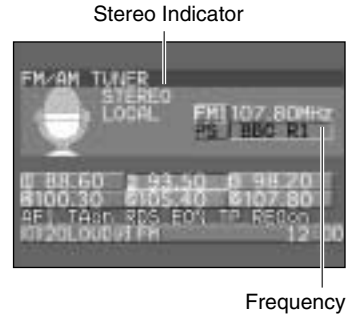

Band

Press **[^]**(BAND) to switch the FM bands as follows.
Press **[v]**(BAND) to switch to the AM(LW/MW) band.



The stereo indicator lights during reception of a stereo broadcast (only for FM bands).

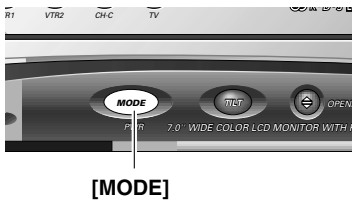

Manual Tuning

Press **[<]** or **[>]** to move to a lower or higher frequency.

Seek Tuning

Press and hold **[<]** or **[>]** for more than 0.5 seconds, then release. The tuning automatically stops at the next station.

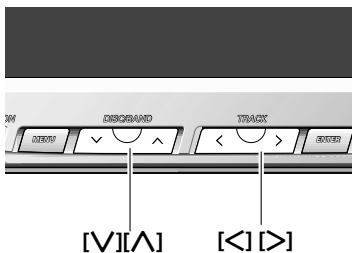

Monaural Mode

Turn Mono on to reduce noise when receiving a stereo broadcast.

Press **[ENTER]** to switch the MONO mode on or off.



Local Mode (only for remote control)

Receives in strong stations only when performing the seek tuning.

Press **[LOC]** to switch the LOCAL mode on or off.



Station Preset

FM1, FM2, FM3 and AM(LW/MW) can store a maximum of 6 stations each in their preset station memories.

Manual Station Preset

Store the currently received station to any of the preset buttons [1] to [6]. (Up to 6 stations can be memorized per band.) (Only for remote control)

- ① Press [\wedge] or [\vee] to select a desired band.
- ② Use manual or seek tuning to find a station which is to be preset in the memory.
- ③ Press and hold one of the preset buttons [1] to [6] until the display blinks. (Only for remote control)



Preset memory table

Note: Preset memory or auto preset memory operation deletes the previously set station and presets the newly selected station in its place.

Auto Station Preset

Activate the automatic search for the strongest available stations on the presently received band, starting from the lowest frequency. Then store the stations offering the best reception to preset buttons [1] to [6]. (Up to six stations can be memorized per band.) (Only for remote control)

Select a band, press and hold [ENTER] for more than 2 seconds.

- The 6 strongest available stations will be automatically set in the memory on preset buttons [1] to [6]. (Only for remote control)
- Once set, the preset stations are sequentially scanned for 5 seconds each.

Note: Preset memory or auto preset memory operation deletes the previously set station and presets the newly selected station in its place.

Tuning in to a Preset Station

This is how to tune in to a station stored in the memory by Manual or Auto Station Preset.

Press any of the buttons [1] to [6] to tune in to the preset station. (Only for remote control)

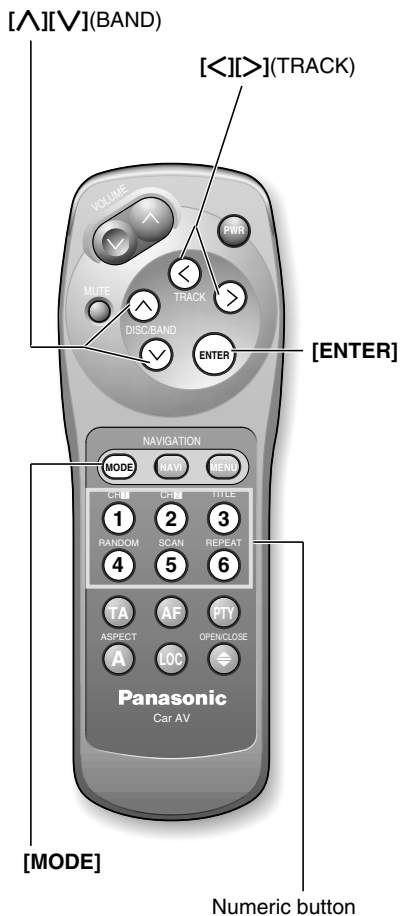

Numeric button

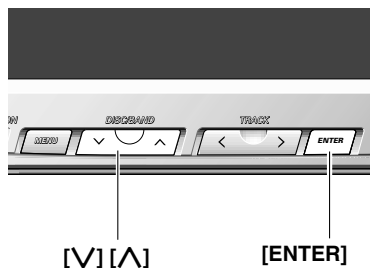

[v][^]

[ENTER]

Radio Data System (RDS)

Some FM stations are broadcasting added data compatible with RDS. This radio set offers convenient functions using such data.

RDS service availability varies with areas. Please understand if RDS service is not available in your area, the following service is not available, either. This chapter explains the summary and operation regarding RDS.

RDS Basics

The following functions are available when receiving RDS stations.

- **Program Service Name Display (PS Display)**

The name of station is displayed instead of the frequency.

Note: It seldom happens that PS display does not show the information correctly because a special font is used. However, this is not due to malfunction.

- **Clock Time Service (CT Service)**

When receiving an RDS station, the CT (Clock Time) service automatically adjusts the time and date.

- **Alternative Frequency (AF)**

When reception is poor, an RDS station broadcasting the same program is tuned in automatically.

- **Region Mode**

Changes the selection range of AF and Best Station Search. (⇒ page 37 for Best Station Search)

Traffic Announcements

Some RDS FM stations periodically provide traffic information.

- **Traffic Program (TP)**

Broadcasting of traffic information

- **Traffic Announcements (TA)**

Radio announcements on traffic conditions

Program Type Display

- **Program Type (PTY)**

RDS FM stations provide a program type identification signal.

Example: news, rock, classical music, etc.

Enhanced Other Networks (EON)

When EON data is received, the EON indicator lights and the TA and AF functions are expanded as follows.

TA : Traffic information from the current and other network stations can be received.

AF : The frequency list of preset RDS stations is updated by EON data.

EON enables the radio to make fuller use of RDS information. It constantly updates the AF list of preset stations, including the one currently tuned in to. For example, if you preset a station far from home, you will later be able to receive the same station at an alternative frequency, or any other station serving the same program. EON also keeps track of locally available TP stations for quick reception.

Emergency Announcement

Reception

FM mode

When an emergency announcement is broadcast, the unit is automatically switched to receiving that broadcast.

Other mode

If this happens in a mode other than radio mode (CD changer mode, VTR1 mode, VTR2 mode) or in Muting in TA mode, "Alarm!" lights on the display. (⇒ page 39 for Muting in TA mode)

Note: When LW/MW mode is activated, an emergency announcement can not be received automatically.



Alternative Frequency (AF)

When reception is poor, an RDS station broadcasting the same program is tuned in automatically. AF sensitivity can be selected. [Default: AF1]

Press **[AF]** to change AF mode as follows. (Only for remote control)

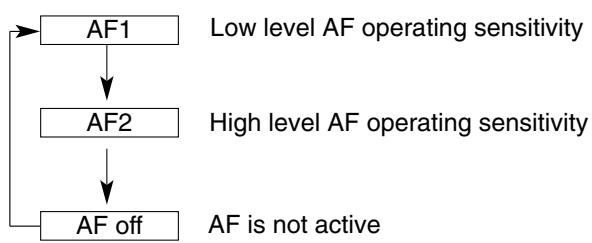

Auto Preset Memory

Auto preset memory works only for RDS stations when the AF mode is on. (→ page 35 about auto preset memory)

Best Station Search

Best Station Search is automatically activated to store the station with the best reception for each preset button.

Region Mode

Changes the selection range of AF and Best Station Search. (→ page 38 about Region on or off)

Radio Data System (RDS) (Continued)

Region Setting

Changes the selection range of AF and Best Station Search. [Default: REGION OFF]

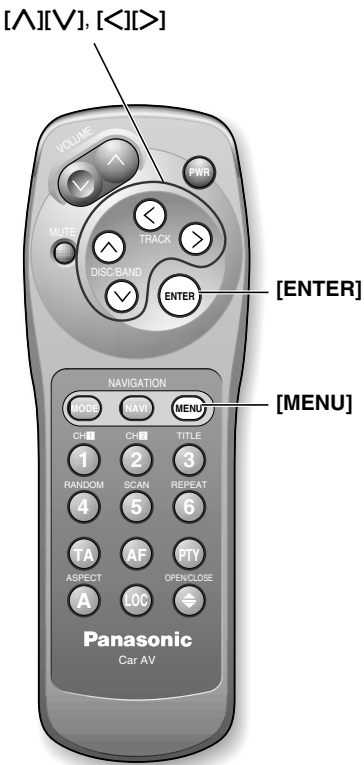

① Press **[MENU]** to display the main menu. Press **[<]** or **[>]** to select "RDS". Press **[V]** or **[^]** to select "REGION".

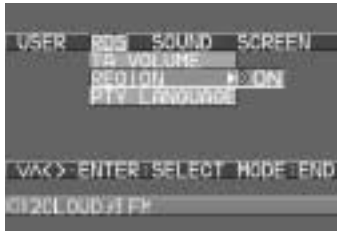

② Press **[ENTER]** to switch the region mode as follows.

REGION ON	The frequency is changed only for programs within the region.
↕	
REGION OFF	The frequency is changed also for programs outside the region.

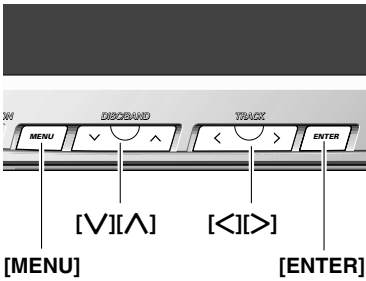

Notes:

- Press **[MODE]** to close the main menu and the setting/adjusting menu.
- Press **[MENU]** in the setting/adjusting menu to return to the main menu mode.
- The setting/adjusting menu is automatically closed if no operation is performed for about 10 seconds.

Traffic Announcement (TA)

Some RDS FM stations periodically provide traffic information. Traffic programs can be received automatically. [Default: TA off]

Press **[TA]** to switch TA mode as follows. (Only for remote control)

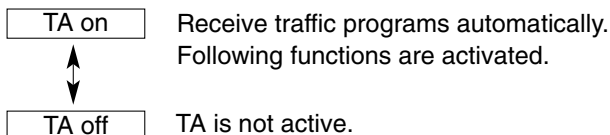

[TA]

Seek tuning and auto preset memory

Seek tuning and auto preset memory work only for TP stations when TA mode is on.

TA Volume

The TA volume can be adjusted to a level different from the regular volume. (→ page 40)

Muting in TA Mode

To listen only to traffic announcement while muting.

- ① Adjust the TA volume. (→ page 40)
- ② Set the regular volume level to 0. (→ page 32)

TA Stand By

Even when the CD changer, the VTR1 or VTR2 mode is selected, FM traffic announcements will interrupt them.

(If **[TA]** is pressed in the CD changer, the VTR1 or VTR2 mode when TA is off, traffic announcements will similarly interrupt.)



Radio Data System (RDS) (Continued)

TA Volume (TA VOLUME)

Set the volume of traffic announcements (TA). [Default: 24]

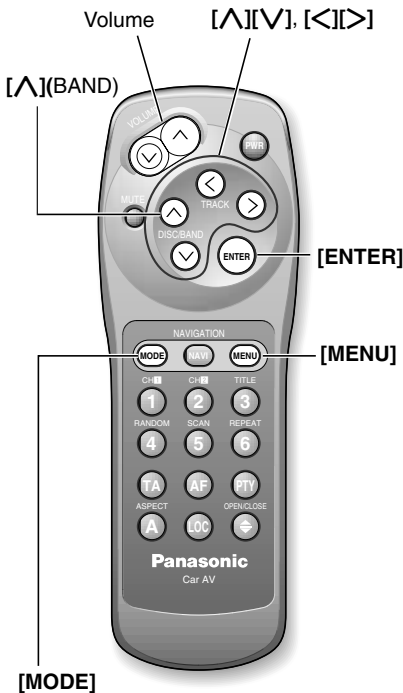

- Press **[MENU]** to display the main menu. Press **[<]** or **[>]** to select "RDS". Press **[^]** to select "TA VOLUME". Press **[ENTER]** to set the TA volume.



- Press **[^](VOLUME)** or **[V](VOLUME)** to increase or decrease the TA volume.

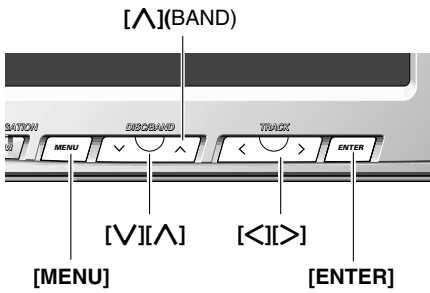
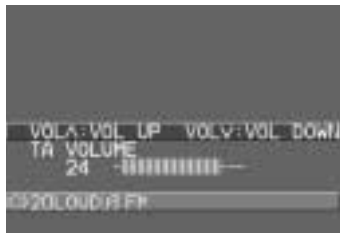

Notes:

- Press **[MODE]** to close the main menu and the setting/adjusting menu.
- Press **[MENU]** in the setting/adjusting menu to return to the main menu mode.
- The setting/adjusting menu is automatically closed if no operation is performed for about 10 seconds.

Program Type (PTY) Display

RDS FM stations provide a program type identification signal.
Example: news, rock, classical music, etc.

[Default: PTY off]

Press **[PTY]** to switch the PTY mode as follows. (Only for remote control)

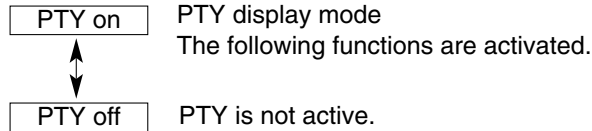

Note: When PTY is activated, band mode switching can not be performed. If it is necessary to switch the band mode, inactivate PTY.

PTY Language

PTY display language can be changed. (→ page 43)
English, German, Spanish, Swedish, Italian, French, Dutch

PTY Selection

① Press **[>]** to change the program type as follows. (**[<]** : opposite direction)

SPEECH	→	MUSIC	→	News	→
Current Affairs	→	Information	→	Sport	→
Education	→	Drama	→	Cultures	→
Science	→	Varied Speech	→	Pop Music	→
Rock Music	→	Easy Listening	→	Light Classics M	→
Serious Classics	→	Other Music	→	Weather & Metr	→
Finance	→	Children's Progs	→	Social Affairs	→
Religion	→	Phone In	→	Travel & Touring	→
Leisure & Hobby	→	Jazz Music	→	Country Music	→
National Music	→	Oldies Music	→	Folk Music	→
Documentary	→	SPEECH			

② Select a desired program and press and hold **[ENTER]** for more than 2 seconds. Seek will start to tune in to a station broadcasting the selected program type.

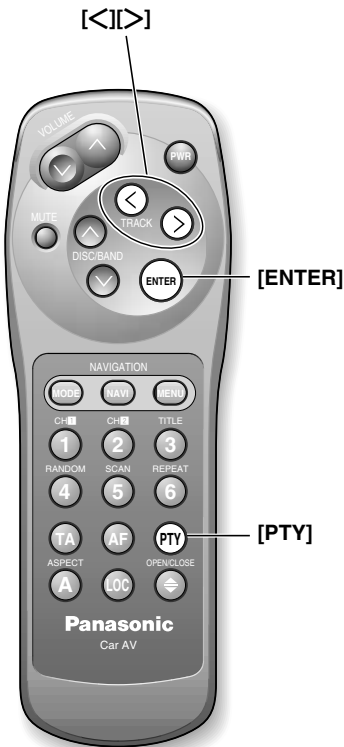

Radio Data System (RDS) (Continued)

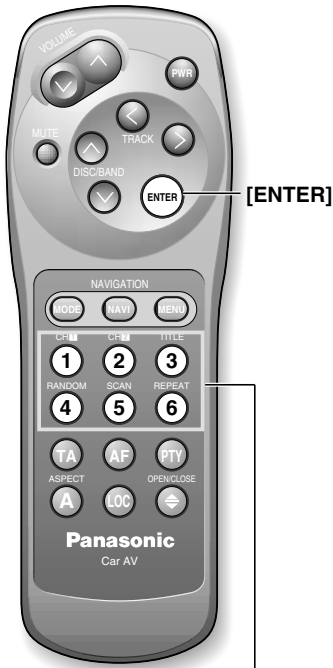

Numeric button

PTY Preset

Program types are stored in memory under the preset buttons [1] to [6] shown in the table below.

To tune in to the desired program type, press any of the preset buttons [1] to [6].

PTY Search

If a preset call has failed, search the program type station as follows.

- ① Select a program type by pressing the preset button.
The preset program type appears on the display for 5 seconds.
- ② Press the same preset button again (or hold [ENTER] for more than 2 seconds) to tune in to the desired program type station.

PTY Preset Change

- ① Select a program type.
- ② Press and hold one of the preset buttons [1] to [6] for more than 2 seconds to store in the memory.

Preset No.	Program Type	Display	
1	News	ⓂNews 1	News
2	Speech	ⓂSPEECH 2	Affairs / Info / Educate / Drama / Cultures/ Science Varied / Weather / Finance / Children / Social Religion / Phone In / Travel / Leisure / Document
3	Sport	ⓂSport 3	Sport
4	Pop. Music	ⓂPop M 4	Pop M
5	Classic Music	ⓂClassic 5	Classics
6	Other Music	ⓂMUSIC 6	Rock M / Easy M / Light M / Other M / Jazz / Country Nation M / Oldies / Folk M

PTY Language

Changes the program type (PTY) display language. [Default: English]

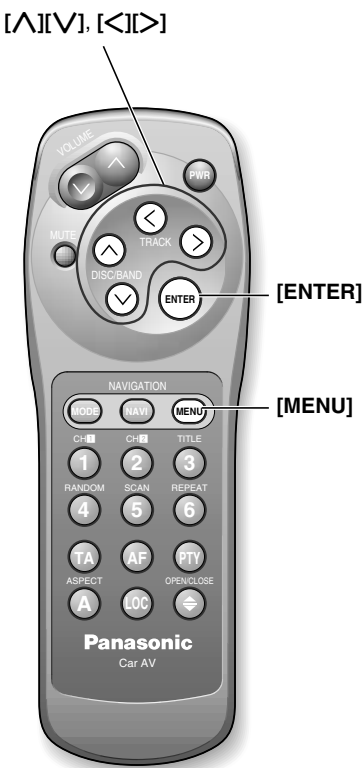

① Press **[MENU]** to display the main menu.
Press **[<]** or **[>]** to select "RDS". Press **[V]** or **[^]** to select "PTY LANGUAGE".



② Press **[<]**, **[>]**, **[V]** or **[^]** to select the language.



③ Press **[ENTER]** to set the PTY language.

Note: Some languages are not available in certain channels.

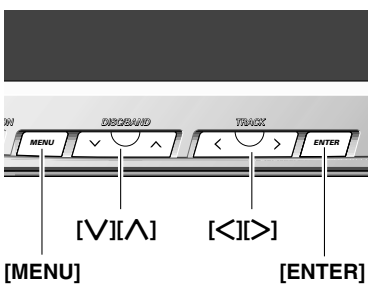

Notes:

- Press **[MODE]** to close the main menu and the setting/adjusting menu.
- Press **[MENU]** in the setting/adjusting menu to return to the main menu mode.
- The setting/adjusting menu is automatically closed if no operation is performed for about 10 seconds.

CD Changer Basics

- An optional changer (CX-DP88N, for example) must be connected.
- Use of the optional Dual CD Changer Control Unit (CA-CD55EN) allows you to connect two CD changers (dual changers). (→ page 60)
- When the unit is connected with a CD text recognizable CD changer (CX-DP9061EN, for example), CD text can appear on the display.

Starting the CD Changer

Once the CD changer has been connected, press **[MODE]** to change to the CD changer mode as follows.

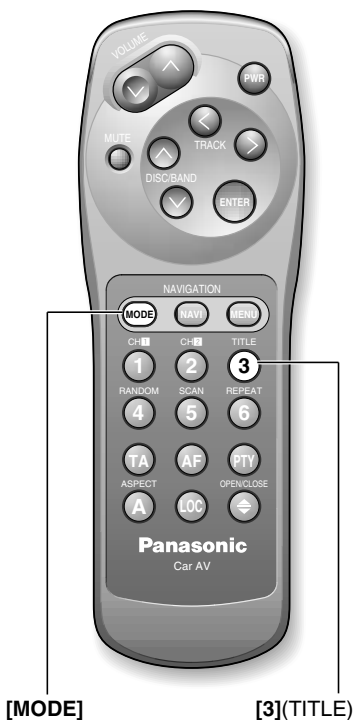

Notes:

- The CH•C mode is not available if no changer is connected.
- If no disc is in the magazine, “NO DISC” appears.
- If the magazine is inserted while power is on, the CH•C mode is automatically selected to start playing.
- If the navigation mode is ON, only the audio signal is switched while the video signal remains as it is.
- The mode can be changed even when the display unit is in the retracted position.

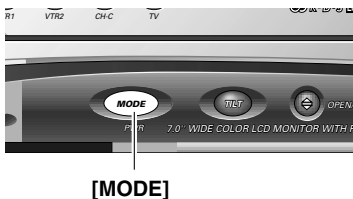
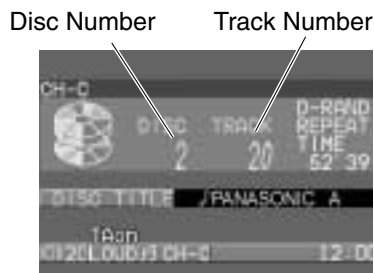

Title Display

Track title or disc title appears on the display only when the unit is connected to a CD changer that can recognize CD text (CX-DP9061EN, for example).



Press **[3](TITLE)** to switch the display between disc title and track title. (Only for remote control)

Notes:

- “NO TITLE” appears on the display if a disc, which does not support the text display, has been loaded.
- Up to 12 characters can be displayed at a time.
- If the text has more than 12 characters, it is shown with up to 48 characters just once by scrolling, then the first 12 characters are kept displayed.



Disc Selection

Press [V](DISC) or [^](DISC) to select a disc in descending or ascending order.

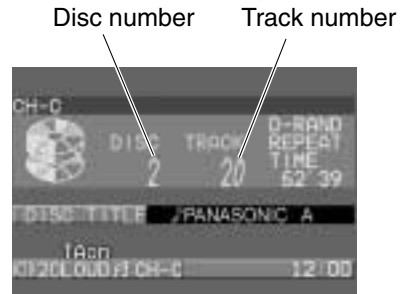

Track Selection

- Press [>](TRACK) to advance to the next track.
- Press [<](TRACK) to start play from the beginning of the track now playing.
- Press [>](TRACK) or [<](TRACK) repeatedly to skip the desired number of tracks.

Track Search

- Press and hold [>](TRACK) or [<](TRACK) for more than 0.5 seconds to advance or reverse through a track.
- Release [>](TRACK) or [<](TRACK) to resume regular CD play from the released position.

Track Random (Only for remote control)

Play the tracks of all discs in the changer in random order.

- Press [4](RANDOM). All the available tracks on all discs in the magazine will be played in a random sequence.

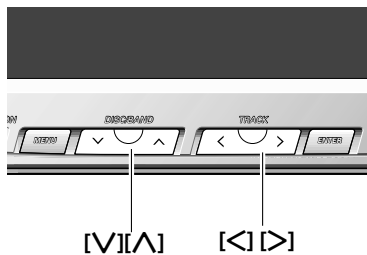

- Press [4](RANDOM) again to cancel.

Disc Random (Only for remote control)

Play the tracks of the disc you are currently listening to in random order.

- Press and hold [4](RANDOM) for more than 2 seconds. All the available tracks on the current disc will be played in a random sequence.



- Press and hold [4](RANDOM) for more than 2 seconds again to cancel.

CD Changer Basics (Continued)

Track Scan (Only for remote control)

Play the first 10 seconds of each track on the disc in sequential order, starting from the track following the one you are currently listening to.

- Press **[5](SCAN)**. The first 10 seconds of each track on the discs play in sequence.

After all tracks are scanned, resume normal play from the start of the original track.



- Press **[5](SCAN)** again to cancel.

Disc Scan (only for remote control)

Play the first 10 seconds of the first track on all discs in the changer in sequential order, starting from the disc following the one you are currently listening to.

- Press and hold **[5](SCAN)** for more than 2 seconds. The 1st track of all the discs in the magazine is played for 10 seconds each. When all discs are scanned, resume normal play from the start of the original disc.



- Press and hold **[5](SCAN)** for more than 2 seconds again to cancel.

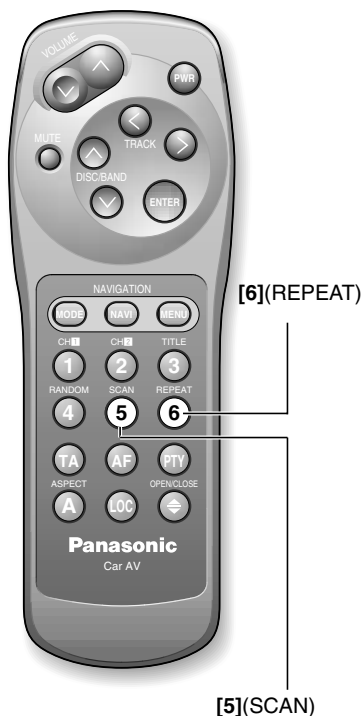

Track Repeat (Only for remote control)

Repeat playing the currently selected track.

- Press **[6](REPEAT)** to repeat the current selection.



- Press **[6](REPEAT)** again to cancel.

Disc Repeat (Only for remote control)

Repeat playing the currently selected disc.

- Press and hold **[6](REPEAT)** for more than 2 seconds to repeat the current disc selection.



- Press and hold **[6](REPEAT)** for more than 2 seconds again to cancel.

Dual CD Changer (Only for remote control)

This function lets you control two CD changers through the optional dual CD Changer control unit (CA-CD55EN).

Change over between two connected CD changers. [Default: CH-1]

Press [1](CH1) or [2](CH2) to select CD changer 1 or CD changer 2. (→ page 60) (Only for remote control)

[1](CH1)
[2](CH2)



CD changer indicator

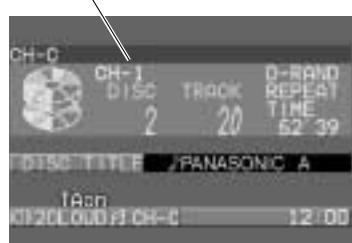

Note: This function is not available when there is no disc in the connected CD changer or when the magazine is not in the changer.

Auxiliary

- Watching the image or listening to the sound of a connected external device
- Connect a mobile video deck, video camera, rear-view camera, or car navigation system, for example.

WARNING:

For safe driving, the operation is possible only when stopped with the parking brake engaged. "WARNING" will be displayed, if you try to switch to VTR1 or VTR2 mode by pressing the [MODE] button while driving.

Notes:

- If your car navigation system is not connected, be sure to set the NAVI (navigation input) to RGB on the setting/ adjusting menu. (⇒ page 22)
- If your rear-view camera is not connected, be sure to set the CAMERA to OFF on the setting/adjusting menu. (⇒ page 22)



[MODE]

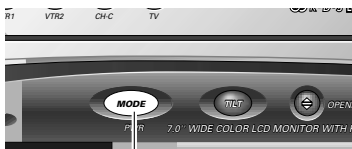

[MODE]

VTR Mode

Press [MODE] to change to VTR1 mode or VTR2 mode as follows.

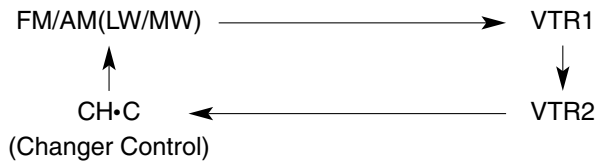

The image supplied by a connected external device is displayed. At the same time, the VTR1 or VTR2 indicator on the front panel of the display unit lights.

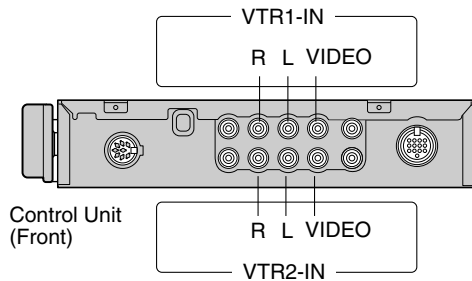

Example of VTR1 mode



ALARM indicator



Emergency Announcement

When an emergency announcement is received in VTR mode, "ALARM!" lights and that announcement can be heard.

Notes:

- In VTR1 mode, the video and audio from the external device connected to VTR1-IN are selected.
- In VTR2 mode, the video and audio from the external device connected to VTR2-IN are selected.
- If the navigation mode is ON, only the audio signal is switched while the video signal remains as it is. (⇒ page 33)
- The mode can be changed even when the display unit is in the retracted position.

Aspect Ratio (for VTR Mode)

Press [A](ASPECT) to change the aspect ratio as follows.



[A](ASPECT)



Aspect

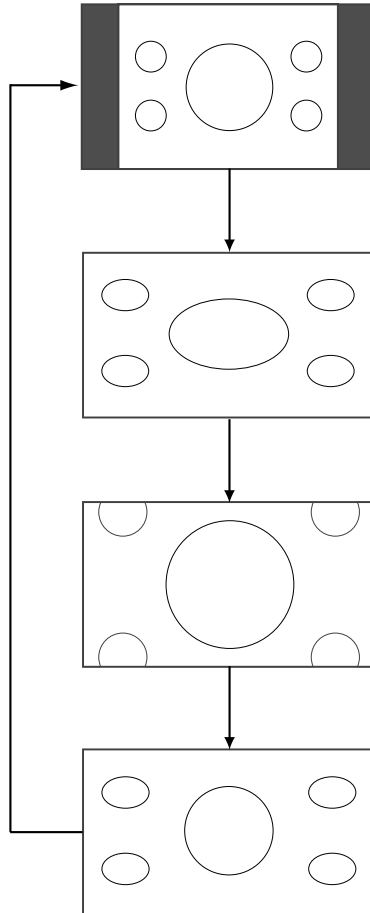

Normal

- The conventional TV image has a 4:3 ratio of horizontal to vertical.
- In this case, a blank area remains on the right and left sides of the display.

Full

- The screen is extended horizontally as a whole to the aspect ratio of 16 to 9.
- The extension ratio is the same at any point of the screen.

Zoom

- The screen is fully extended at the normal aspect ratio of 4 to 3.
- The top and bottom of the screen are slightly cut.

Just

- The screen is extended horizontally to the aspect ratio of 16 to 9.
- The extension ratio increases toward the right and left ends of the screen.

Notes:

- The zoom and just screens do not apply to car navigation images.
- When the rear-view camera is in operation with the gear shift in the reverse (R) position, the image is shown on the full screen only.

Caution:

This is to remind you that compression or extension of the screen using the aspect ratio (screen mode) changing function of this product for commercial purposes or viewing/listening by the public could infringe on the rights of the author protected by the copyright laws.

Installation

Preparation

- When bending the mounting tab of the mounting collar with a screwdriver, be careful not to injure your hands and fingers.
- We strongly recommend you to wear gloves for installation work to protect yourself from injuries.

- Before installation, check the radio operation with antenna and speakers.
- Disconnect the cable from the negative (-) battery terminal (see caution below).
- The unit should be installed in a horizontal position with the front end up at a convenient angle, but not more than 30°.

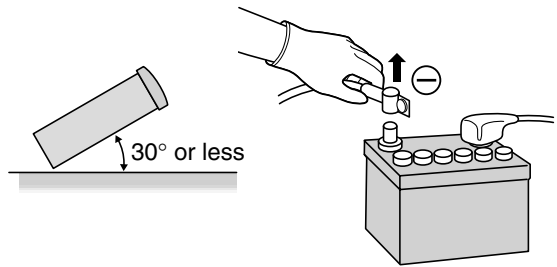

Caution: Do not disconnect the battery terminals of a car with trip or navigational computer since all user settings stored in memory will be lost. Instead take extra care with installing the unit to prevent shorts.

Dashboard Installation

Installation Opening

The unit can be installed in any dashboard having an opening as shown at right. The dashboard should be 4.5 mm - 6 mm thick in order to be able to support the unit.

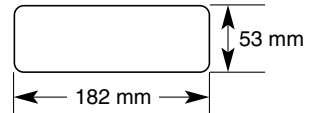

Transportation bracket removal

Be sure to remove the transportation brackets before use (installation).
Use screws (5 mmφ x 6 mm) with washers for installation.
Be careful not to lose these screws.

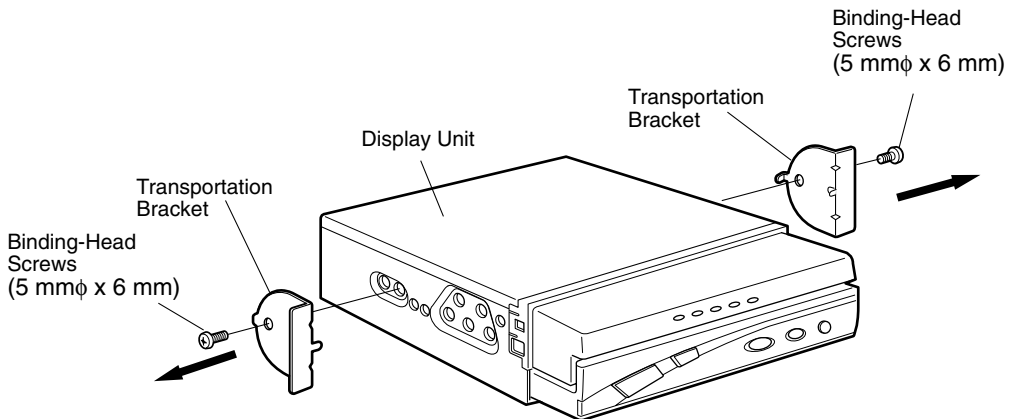

Installation Precautions

This product should be installed by a professional installer, if possible.

In case of difficulty, please consult your nearest authorized Panasonic Service Center.

1. This system is to be used only in a 12-volt, DC battery system (car) with negative ground.
2. Follow the electrical connections carefully (→ pages 55 to 61). Failure to do so may result in damage to the unit.
3. Connect the power lead after all other connections are made.
4. Be sure to connect the battery lead (yellow) to the positive terminal (+) of the battery or fuse block (BAT) terminal.
5. Insulate all exposed wires to prevent short circuiting.
6. Secure all loose wires after installing the unit.
7. Please carefully read the operating and installation instructions of the respective equipment before connecting it to this unit.

Caution: Please follow the laws and regulations of your province or country for installation of the unit .

Installation (Continued)

- When bending the mounting tab of the mounting collar with a screwdriver, be careful not to injure your hands and fingers.
- We strongly recommend you to wear gloves for installation work to protect yourself from injuries.

Installation Procedures

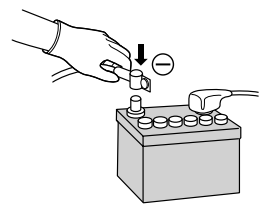
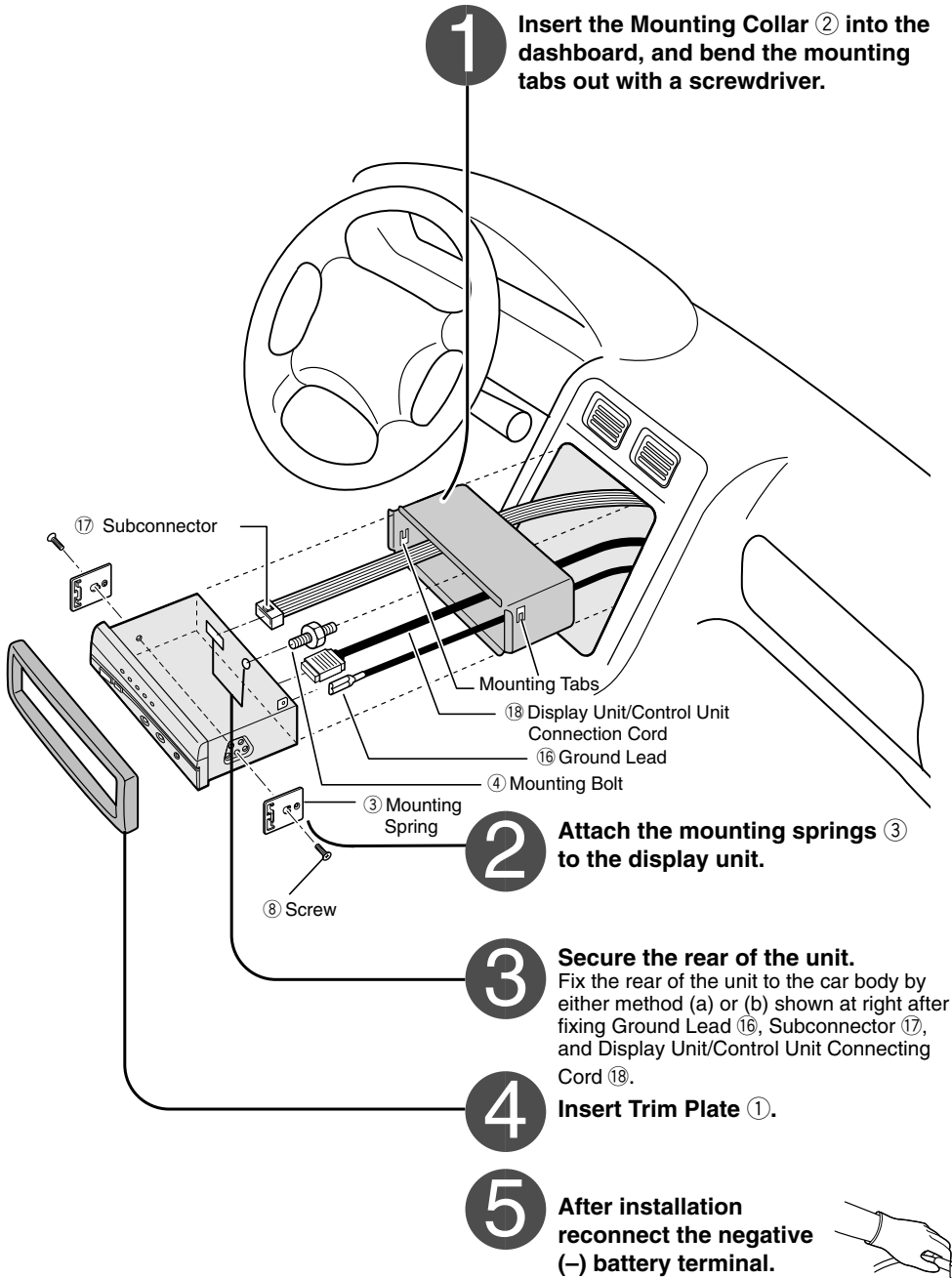

Fastening the Mounting Collar

The tabs to be bent vary depending on the car. Bend them with a screwdriver to fasten the mounting collar ② securely in the dashboard.

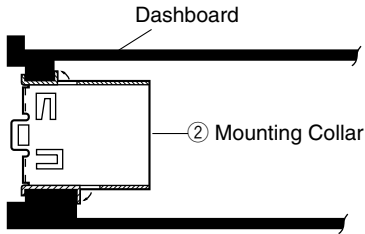

(a) Using the Rear Support Strap ⑦

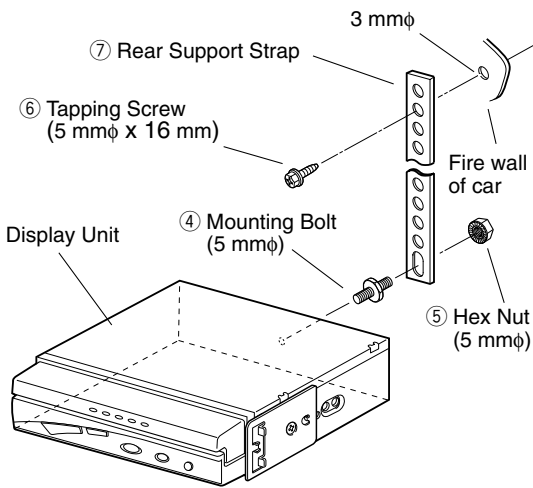

(b) Using the Rubber Cushion (Option)

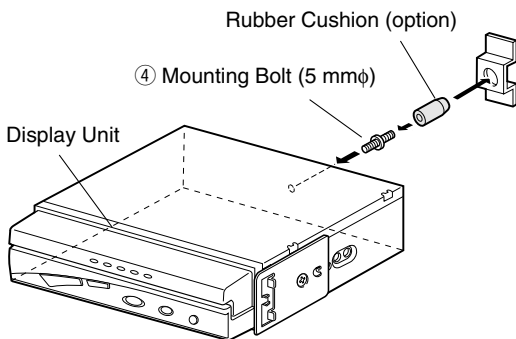

Supplied Hardware

No.	Item	Diagram	Qty
①	Trim Plate		1
②	Mounting Collar		1
③	Mounting Spring		2
④	Mounting Bolt (5 mmφ)		1
⑤	Hex. Nut (5 mmφ)		1
⑥	Tapping Screw (5 mmφ x 16 mm)		1
⑦	Rear Support Strap		1
⑧	Screw (5 mmφ)		2
⑨	Velcro Tape		2
⑩	Remote Control Unit		1
⑪	Battery (UM4)		2
⑫	Power Connector		1
⑬	Reverse Extension Cord		1
⑭	Clip Connector		1
⑮	Wiping Cloth		1
⑯	Ground Lead		2
⑰	Subconnector		1
⑱	Display Unit/Control Unit Connecting Cord		1
⑲	Radio Antenna Extension Cord		1

Installation (Continued)

❑ To Remove the Display Unit

- Push the right and left clamp plates outwards, one at a time, and pull the display unit toward yourself.
- After removing the right and left clamp plates, pull the unit with both hands till it comes off.

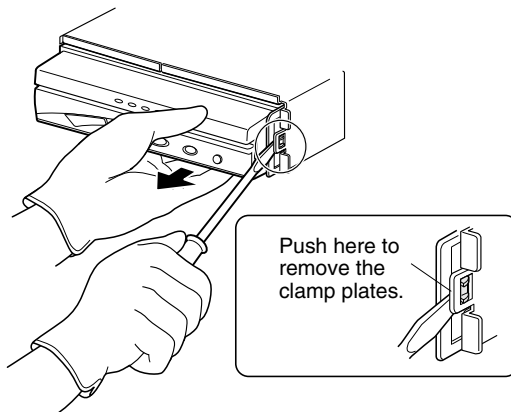
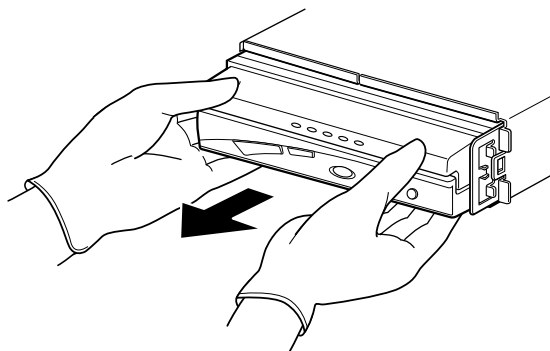

<Mounting the Control Unit>

Mounting Example

Stick Velcro tape ⑨ on the carpet and mount the control unit on it. Connect car radio antenna cord to the control unit using radio antenna extension cord ⑲ between them.

Note: Some carpet materials may not be suitable for this mounting method. In this case, please contact your nearest Panasonic Service center for service.

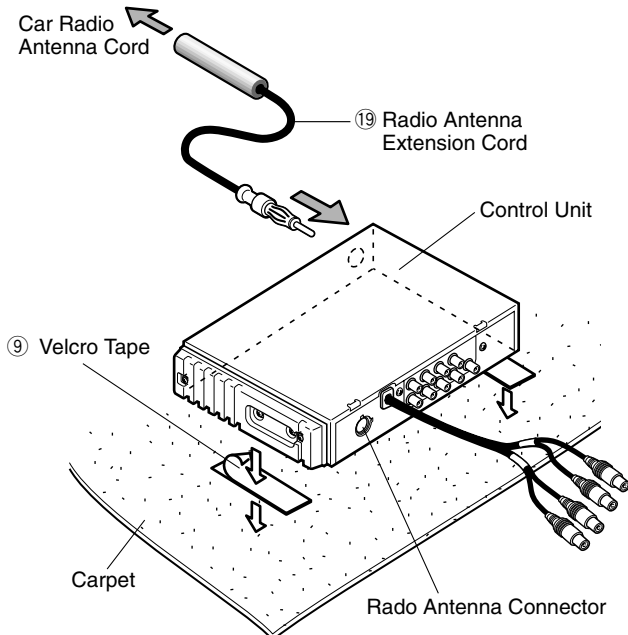

Notes:

- Never mount the control unit in any of the following locations to avoid damage due to overheating:
 1. Near the heater port.
 2. Places like the dashboard or rear deck, where it may be exposed to direct sunlight.
- Do not mount the control unit near the door, where it could be exposed to rain.

Electrical Connections

Cautions:

- To prevent damage to the unit, be sure to follow the connection diagram as follows.
- Remove about 5 mm of protective covering from the ends of the leads before connecting.
- Do not insert the power connector into the unit until the wiring is completed.
- Be sure to insulate any exposed wires to prevent a possible short-circuit from the car chassis. Bundle all cables and keep cable terminals free from touching any metal parts.

Basic System

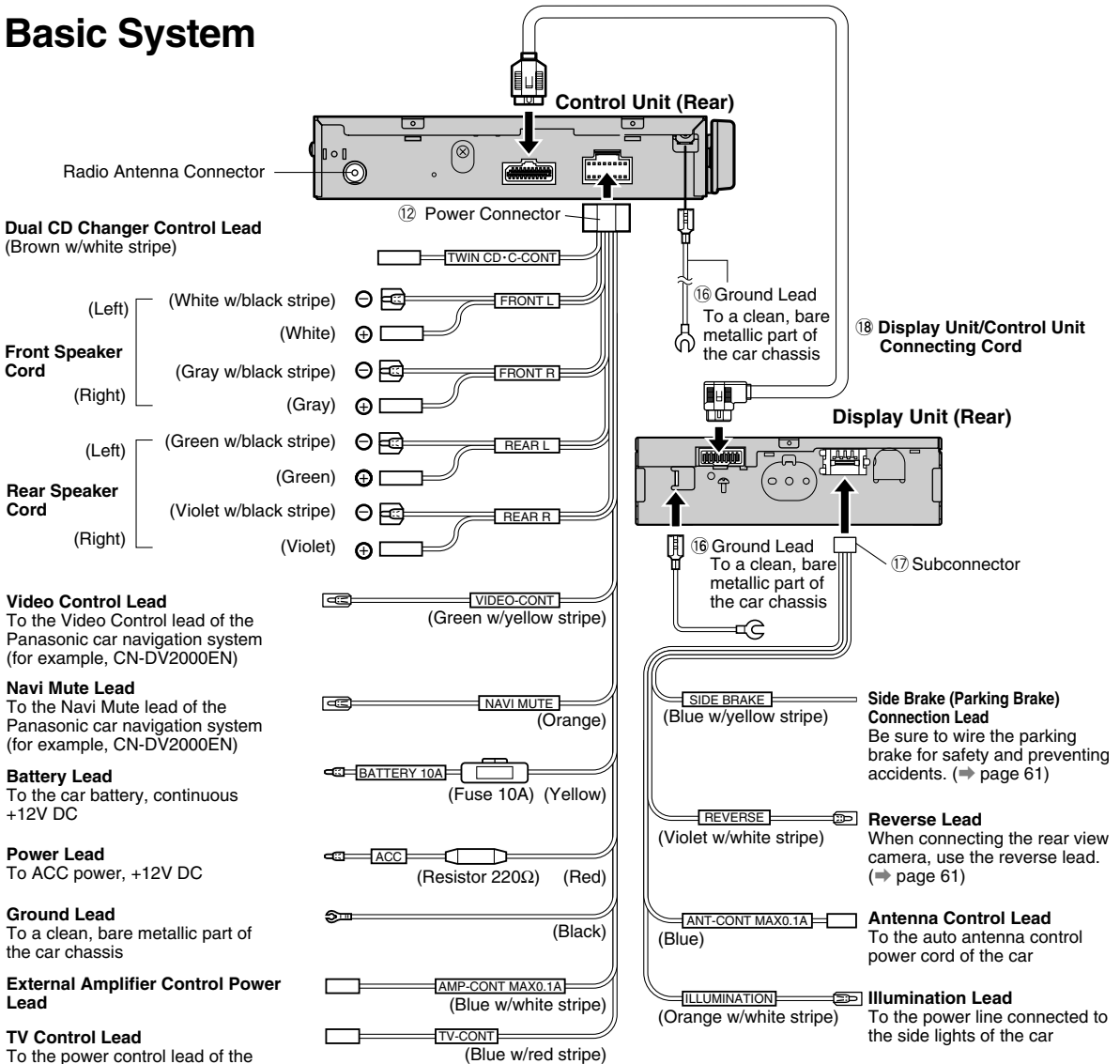

Connecting the Power Source

Notes:

- This monitor system is designed only for use with a 12 volt DC motor vehicle.
- Be sure to fully plug in the connectors.
- Route the cord to avoid high-temperature spots and secure with clamps and tape.
- When game devices are connected, the image may be unstable.
- When removing the DIN plug, be sure to press the clip.

Electrical Connections (Continued)

Example 1: Advanced System Up-grade

Connection with CD Changer (CX-DP9061EN), TV Tuner (CY-TN1500PEN), and Car Navigation (CN-DV2000EN)

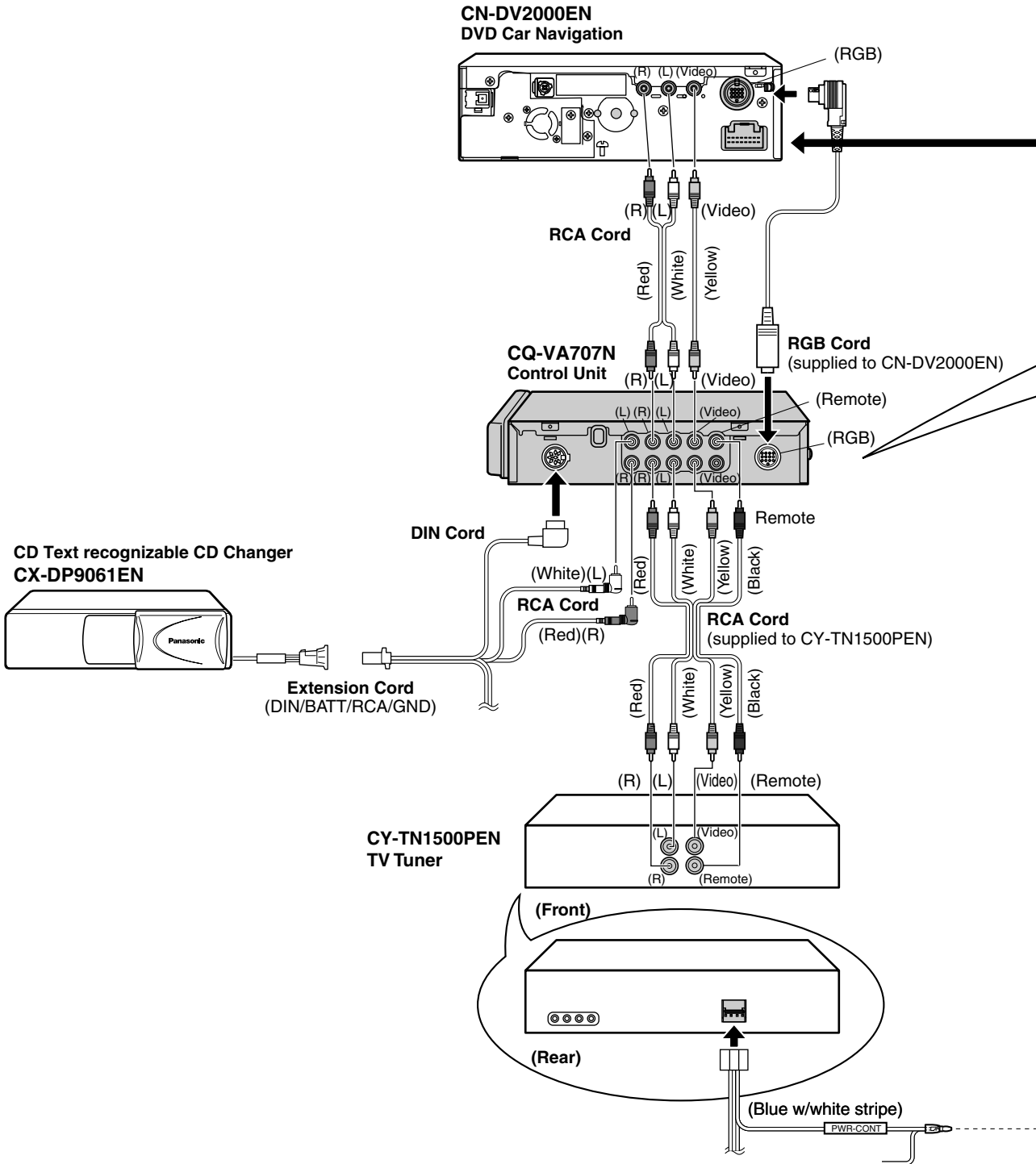

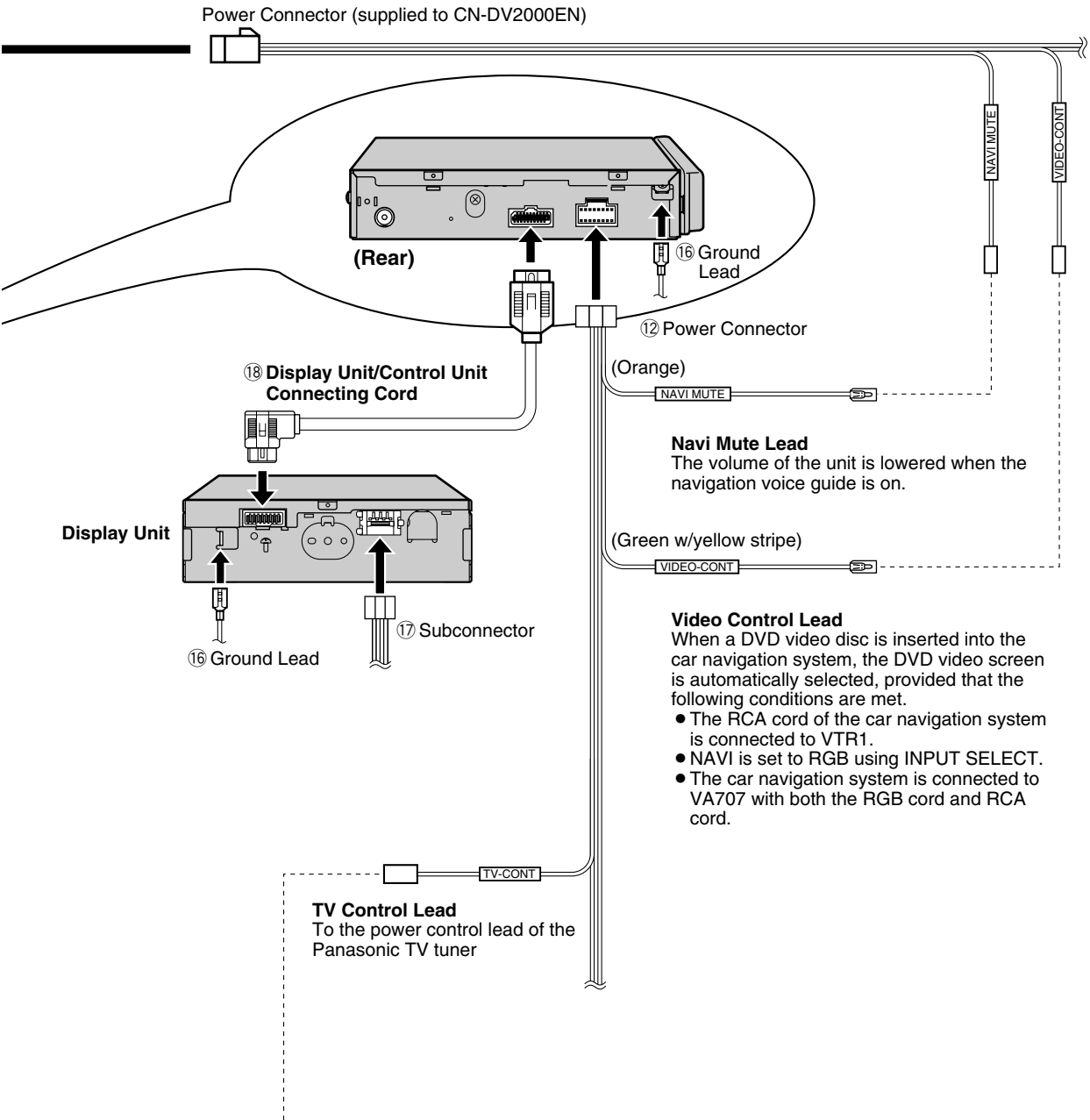

Electrical Connections (Continued)

Example 2: Advanced System

Connection with DVD Player (CX-DV1500PEN), Digital Surround Processor (CY-AC300EX), and Power Amplifiers (CY-M9054EN and CY-M7052EN).

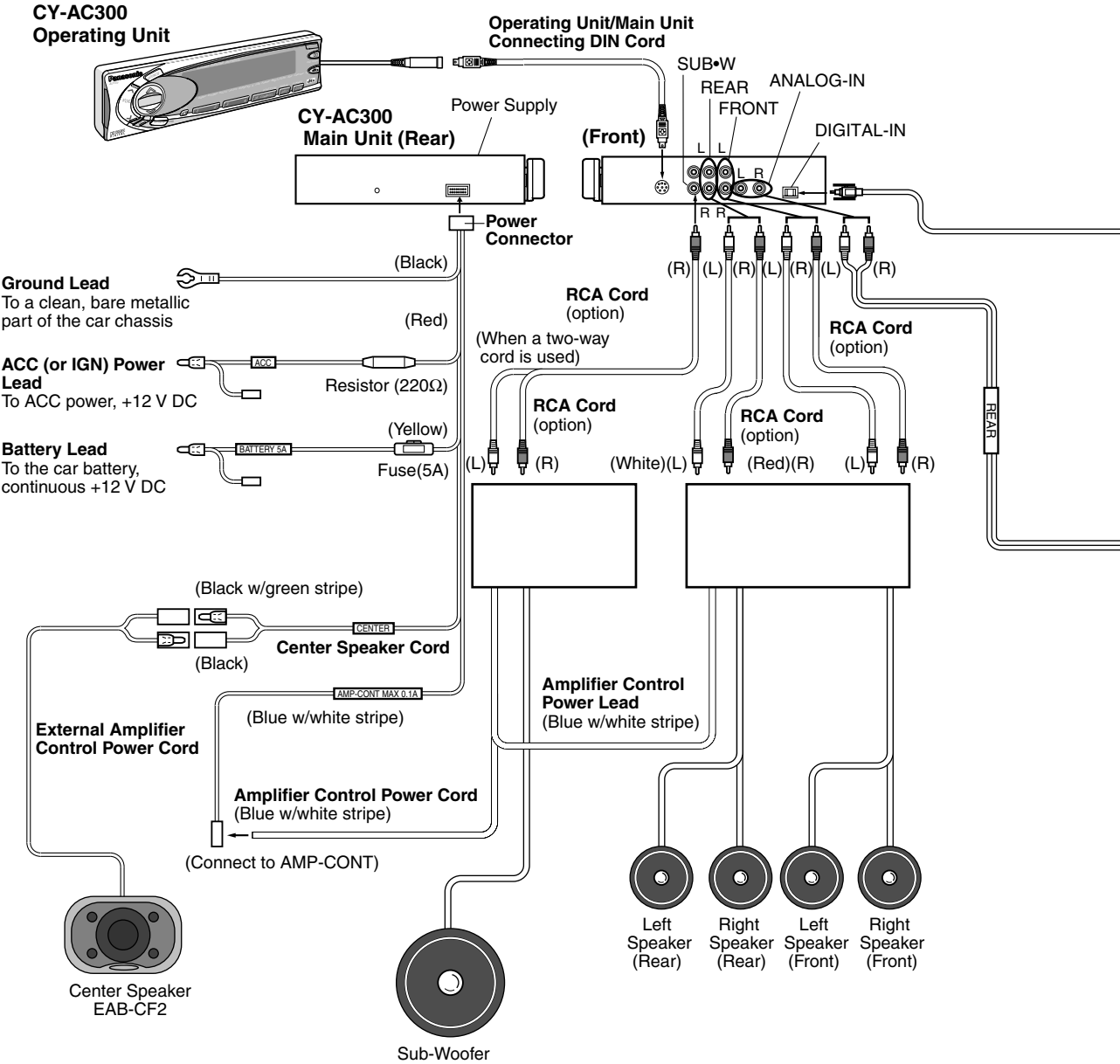

Notes on handling optical fiber cable
 • Do not bend the cable sharply.
 • Do not allow the cable to be damaged by getting it caught in the door, placing a heavy object on it, etc.

Optical Fiber Cable
 (CA-LRD60: option)

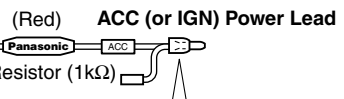
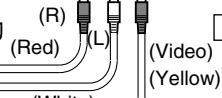
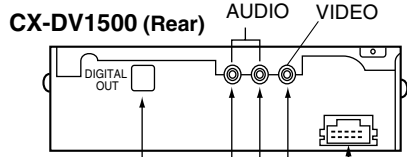

When connected to the external amplifier control power lead (AMP-CONT) of CY-AC300, instead of connecting to the ACC power source, the power of unit can be linked to that of CY-AC300.

Pre-out (Rear)

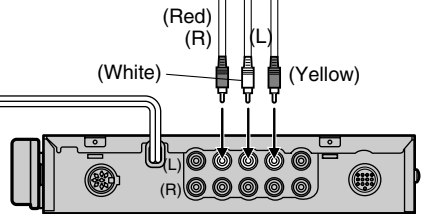

Pre-out (Front)
 Not used

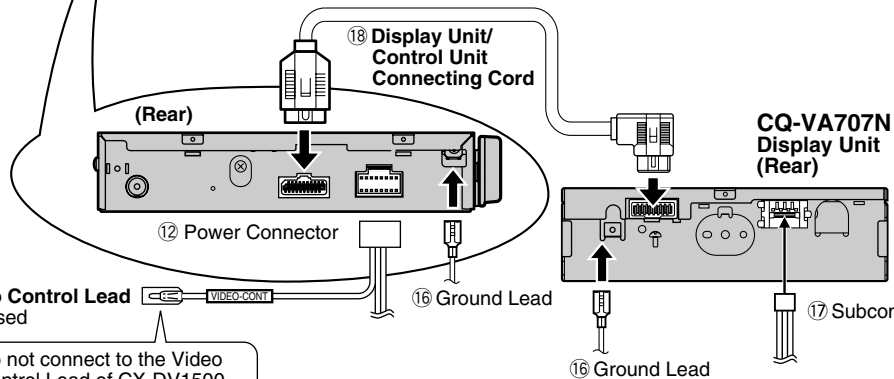

Video Control Lead
 Not used
 Do not connect to the Video Control Lead of CX-DV1500.

Electrical Connections (Continued)

Example 3: Connection with two CD Changers (CX-DP9061EN)

You need the optional dual changer control unit (CA-CD55EN).

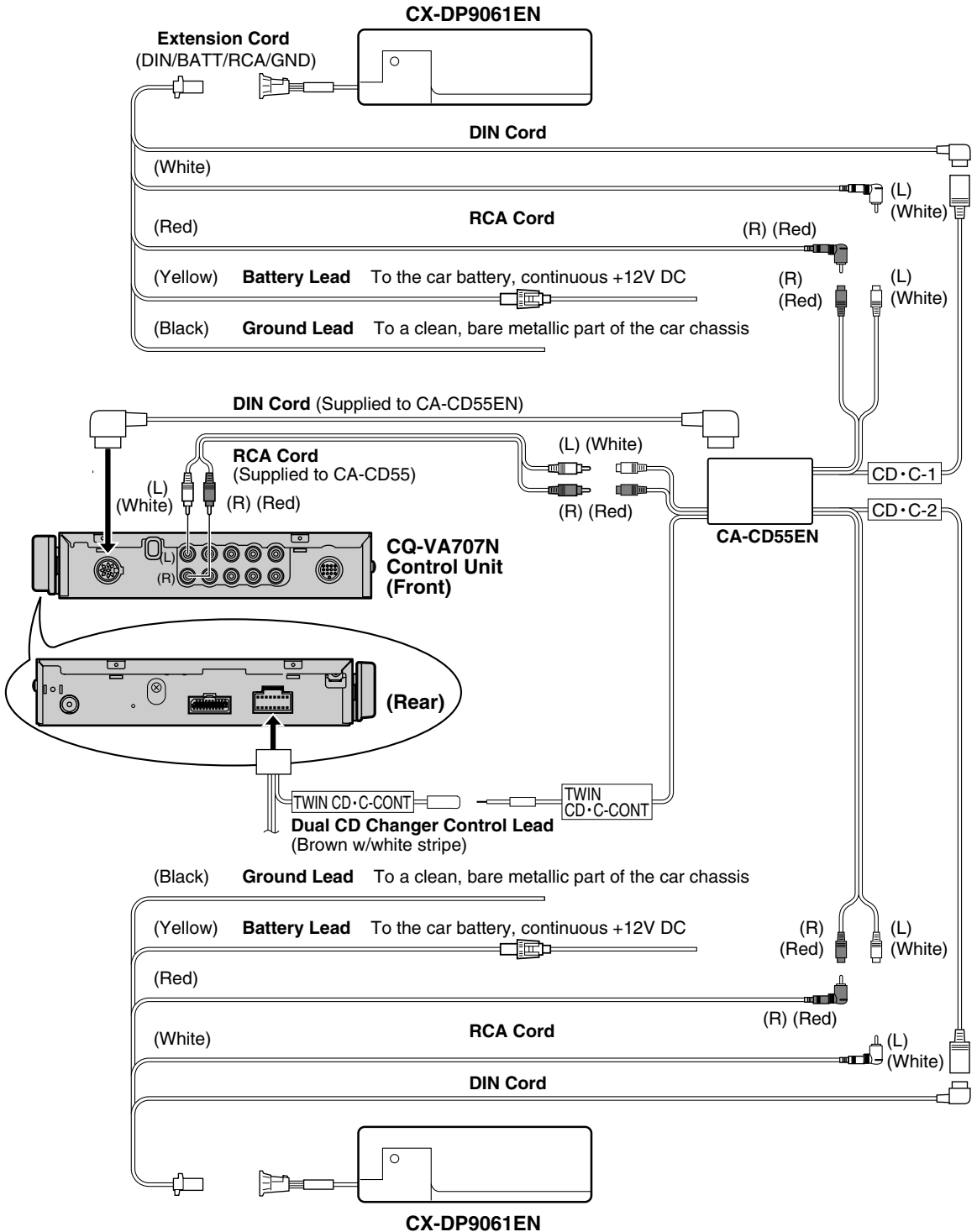

Connecting the Parking Brake Connection Lead

Caution: For safety, be sure to ask your nearest professional installer to do this connection.

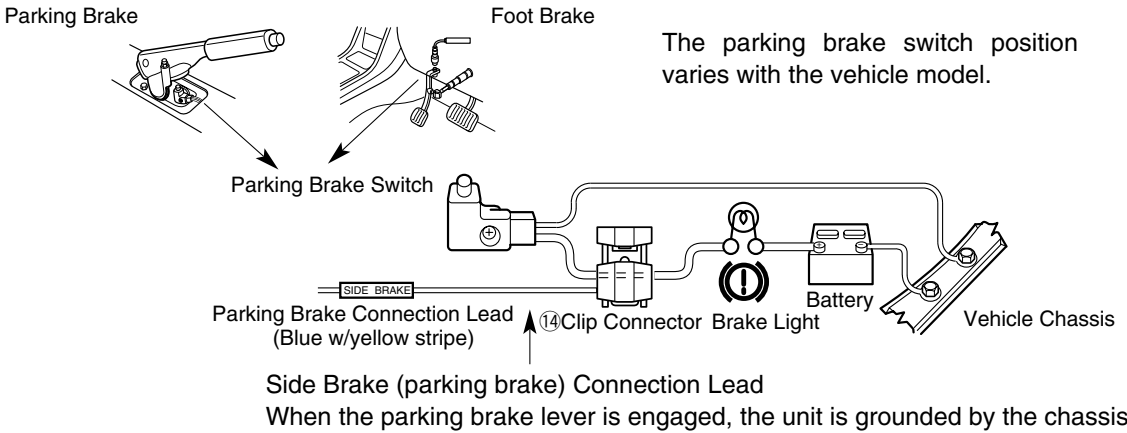

- ❶ Attach a clip connector ⑭ to the end of the parking brake connection lead.
- ❷ The clip connector ⑭ is connected to the power source side lead of the parking brake lever.

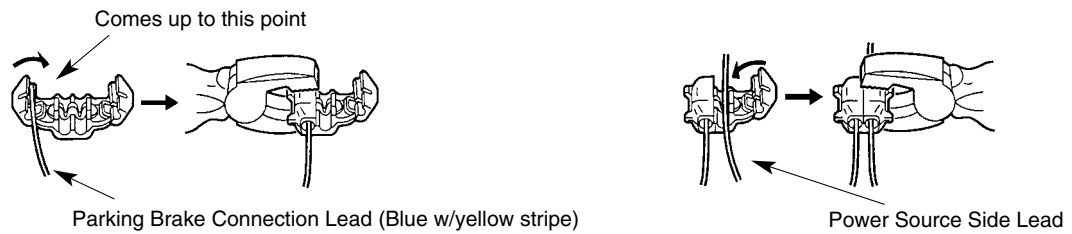

Connecting the Reverse Cord

* In case using an optional rear-view camera, the reverse lead must be connected.

- Connect the reverse lead (violet w/white stripe) to the positive (+) lead of the reverse lamp (the lamp with a clear lens that lights when the transmission gear is shifted into the reverse position).

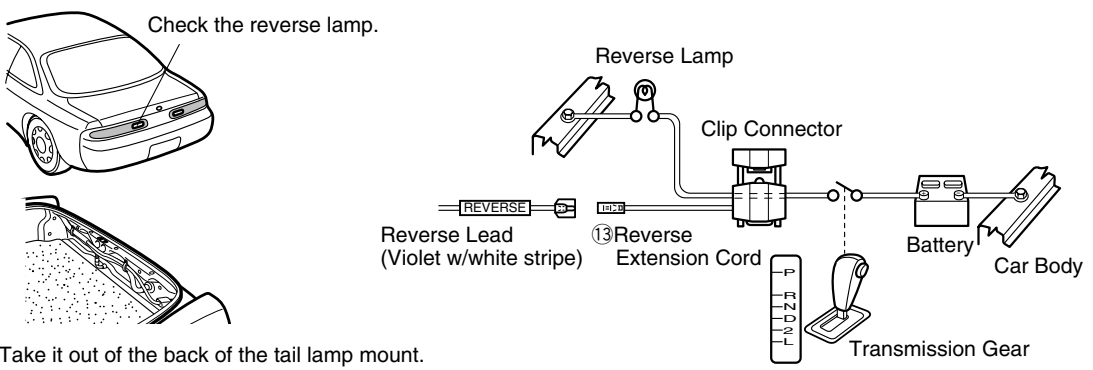

Note: Connect the reverse lead after cutting the terminal at the end.

Troubleshooting

Maintenance

Your product is designed and manufactured to ensure a minimum of maintenance. Use a soft cloth for routine exterior cleaning. Never use benzine, thinner or other solvents. (➔ page 66)

When Something Doesn't Work

Check the charts for possible causes and solutions to any problem you might be experiencing. Some simple checks or minor adjustments may eliminate the problem.

Product Servicing

If the suggestions in the charts don't solve the problem, we recommend that you take it to your nearest authorized Panasonic Service center. The unit should be serviced only by a qualified technician.

Fuse

Use fuses of the same specified rating (10 A). Using different substitutes or fuses with higher ratings, or connecting the unit directly without a fuse, could cause fire or damage to the unit.

If the replacement fuse fails, contact your nearest authorized Panasonic Service Center.

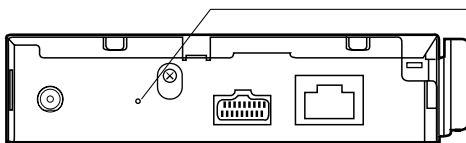

Control Unit (Rear)

Reset Switch

Press the reset switch when any operation buttons do not function. If the unit does not reset even after pressing the switch, contact your nearest Panasonic Service Center for service.

Caution: If you press this switch with a sturdy, pointed object, initial setting is restored. However, all memorized settings are cancelled at that time.

■ Error Display Message (CD Changer)

Display	Possible Cause	Problem	Probable Solution
– E1 –	Disc dirty or wrong side up	Next disc is automatically selected.	Eject magazine and check the disc.
– E2 –	Disc damaged		
– E3 –	Receiver fails to operate	—	Press EJECT button on changer. If trouble persists, press the reset button on changer. Trouble still persists, ask your dealer or nearest service center for repair.
NO DISC	No disc at all in magazine	—	Insert discs into magazine.
NO MAGAZINE	No magazine in the changer	—	Load the changer with the magazine.

Note: Display contents and operations vary in part from one changer to another (due to the differences in changer specifications). For details, refer to the manual of the changer you are using.

Troubleshooting Tips

■ Power

Problem	Possible Cause	Probable Solution
Unit won't turn on.	Dead vehicle battery Ignition not on	Charge vehicle battery. Turn ignition to On or Acc.
	Connections not made correctly	Check connections.
	Bad power battery line connection	Connect battery cables to terminals that are always live.
	Bad accessory line connection	Connect accessory power cord with ACC power supply of the car.
	Bad ground lead connection	Connect ground lead to a metallic part of your car.
	A connecting cord between the display unit and the control unit is not connected correctly.	Check the connecting cord between the display unit and the control unit.
	Fuse burned out	Replace it with one of the specified rating.

Troubleshooting (Continued)

■ General

Problem	Possible Cause	Probable Solution
No sound	Volume is too low.	Raise volume.
	Connections not made correctly	Check connections.
	Condensation	Leave for some time before use.
No sound from built-in speakers	Volume is too low.	Raise navigation volume.
	Navigation volume set to 0	Set navigation volume to higher than 0.
No sound from left, right, front or rear speaker	Left-right, front-rear balance is off.	Properly adjust BAL/FAD.
	Connections not made correctly	Check connections.
Right and left sounds reversed in stereo	Speaker wires are connected incorrectly.	Connect speaker wires correctly.
Tilt angles and forward-backward position of display unit cannot be adjusted.	Obstacle is in the way.	Be careful not to let the cord be caught, and use the display unit in a position free of contact with obstacles.
Display unit cannot be retracted.	Display unit is not in the neutral position of its lateral angle.	Return the display unit to the neutral position of its lateral angle.

■ Display

Problem	Possible Cause	Probable Solution
No image	Dimmer, contrast, bright, color, tint not adjusted properly.	Adjust each of these screen adjustment items (dimmer, contrast, bright, color, tint).
Screen too dark		
Screen whitish		
Tone not good, colors too light		
 Red, blue or green spot	This is a characteristic of liquid crystal panels and is not a problem.	

■ VTR, AV, CAMERA (Video, Video Camera, Rear View Camera)

Problem	Possible Cause	Probable Solution
No image from VTR or video camera	VTR or video camera is not correctly connected. Correct mode is not selected.	Connect VTR or video camera correctly, and change the mode to correspond to the device connected.
No image from rear-view camera	Rear-view camera is not correctly connected.	Connect rear-view camera correctly.
	Camera input is not set correctly.	Set camera input correctly.
Colors are not correctly reproduced.	Display brightness and colors are not correctly adjusted.	Adjust display brightness and colors.
Rough screen	Setting PAL/NTSC is not correct.	Set PAL/NTSC correctly.

■ Radio

Problem	Possible Cause	Probable Solution
Much noise in FM stereo and monaural broadcasts	Station is too far or signals are too weak.	Tune in to a station emitting strong signals.
Presettings lost from memory	Bad power battery line connection.	Connect battery cables to terminals that are always live.
	Fuse for battery power cables is blown.	Replace it with one of the specified rating.
Switching the band mode can not be performed.	PTY is activated.	Inactivate PTY and switch the band mode.

■ Remote Control

Problem	Possible Cause	Probable Solution
No operation by pressing buttons	Battery inserted in wrong direction.	Insert a battery correctly.
	Battery has run down.	Replace battery.
	Remote control not in correct direction.	Direct the remote control at the remote control sensor on the display unit.

Maintenance

To prevent damage to the system exterior

Do not apply pesticides, benzene, thinner or other volatile substances to the unit.

The cabinet surface primarily consists of plastic materials.

Do not wipe with benzene, thinner or similar substances because this will result in discoloration or removal of the paint.

When a cloth with a cleansing chemical is used, follow the caution notes.

Do not leave the unit in contact with rubber or vinyl products for long periods of time.

Do not use cleansers which have polishing granules because this could damage the surface of the unit.

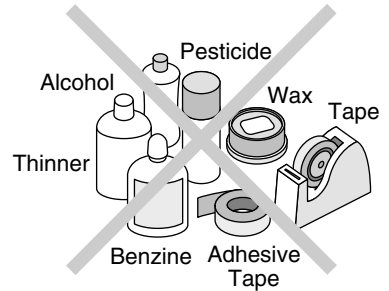

Clean dirt by wiping lightly with a soft cloth

When the unit is dirty, wipe the surface of the display using Wiping Cloth ⑮, an accessory to the unit.

■ Without a Wiping Cloth

When the unit is dirty, wipe with a well-wrung cloth dipped in a liquid dishwashing detergent (neutral) diluted with water and then go over the same surface with a dry cloth.

(Since there is the possibility of water drops getting inside of the unit, do not directly apply cleanser to the surface.)

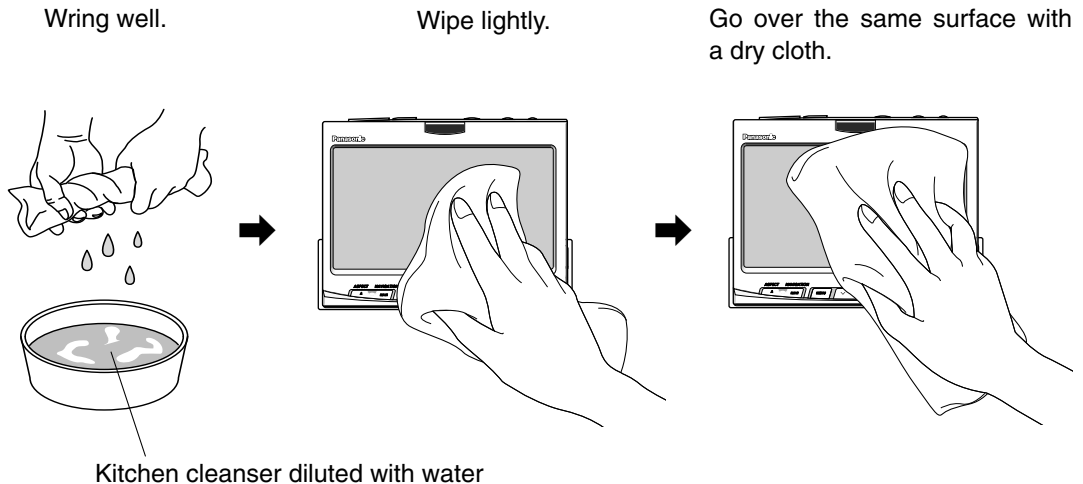

Caution: If water drops or similar wet substances get inside the monitor, it may cause a malfunction.

Specifications

General

Power Supply	: 12 V DC (11 V - 16 V), test voltage 14.4 V negative ground
Current Consumption	: 7 A (at rated VTR operation output)
Audio Input Sensitivity	: 0.5 Vrms (VTR)
Pre-output Voltage	: 4 V (CD Changer Play Mode; 1 kHz 0 dB)
Video input signal	: Composite video signal, 1.0 Vp-p (75 Ω)
Video output signal	: Composite video signal, 1.0 Vp-p (75 Ω)
Dimensions	
Display Unit	: 178 (W) x 50 (H) x 160 (D) mm
Control Unit	: 215 (W) x 41 (H) x 150 (D) mm
Weight	
Display Unit	: 1.9 kg
Control Unit	: 1.2 kg

Display Unit

Liquid Crystal Panel	: 7 inches wide
Screen Dimensions	: 156 (W) x 87 (H) x 178 (D) mm
Number of Pixels	: 336,960 pixels (234 vertical x 480 horizontal x 3)
Valid Pixel Ratio	: over 99.99 %
Display Method	: Transparent color filter format
Drive Method	: TFT (Thin Film Transistor) active matrix format
Light Source	: Internal light (built-in small fluorescent lamp)
Speaker	: 36 mm round speaker (one)
Sound Output	: 0.7 W

Control Unit

FM Stereo Radio

Frequency Range	: 87.5 – 108 MHz
Usable Sensitivity	: 8 dB/μV (S/N 30 dB)
Stereo Separation	: 35 dB (at 1 kHz)

MW Radio

Frequency Range	: 531 - 1,602 kHz
Usable Sensitivity	: 28 dB/μV (S/N 20 dB)

LW Radio

Frequency Range	: 153 - 279 kHz
Usable Sensitivity	: 35 dB/μV (S/N 20 dB)

Note: Specifications and design are subject to modification without notice due to improvements in technology.

Matsushita Electric Industrial Co., Ltd.

Central P.O. Box 288, Osaka 530-91, Japan